

ULISSE

POSITIONING UNIT

REVISION 1115



MAIN FEATURES

- Integrated housing, P&T head and telemetry receiver
- Horizontal Continuous rotation
- IP66
- Variable speed: 0.02°-100°/s Pan and 0.02°-40°/s Tilt
- Configuration through OSD (On Screen Display)
- Versions with built-in wiper
- Available version with SONY day/night camera 36x
- Available version with encoders for positioning feedback
- Multiprotocol

DESCRIPTION

ULISSE has been specifically created for applications of video surveillance in external environments. This new positioning system integrates a high performance P&T head with camera housing and telemetry receiver in a particularly elegant design.

The rotation on the horizontal axis is continuous with a variable speed up to 100°/s while the amplitude on the vertical axis varies from +90° to -40° with a max speed of 40°/s. ULISSE controls the functions of autopan and patrol with a tracking accuracy of 0.02° on preset positions upon recall. Patrol sequences can also be varied with different speed settings in order to customize a perfect patrol pattern.

ULISSE is equipped with a thermostatically controlled heater and sunshield assuring an optimal operating temperature; reinforced heater for temperature down to -30°C (-22°F) also available. A built-in wiper option is available which does not interfere with the viewing range of the installed camera.

This system can also be equipped with incremental encoders which guarantee a real position in any operating condition.

Available version with SONY block camera which combines an incredible 36x optical zoom with an EXview-type HAD CCD 1/4" sensor ensuring a high sensitivity in poorly lighted environments. The camera features a wide excursion angle of view from from 57,8°, in WIDE mode, up to 1,7° in ZOOM/TELE mode.

In addition to the OSD set-up, the system is equipped with an RS232 interface allowing the possibility to update to the latest firmware version. The positioning system is controlled through RS485/RS422. The telemetry signal can be transmitted in an active way for chain configuration of several ULISSE units together.

The positioning unit can be used in installations such as: coast and border patrol, harbour control, urban settings, highway and traffic monitoring, stadiums, industries, prisons or military applications, and perimeter surveillance.



UPT1SVWA000E



ULISSE + UPTWBTA

AVAILABLE MODELS						
Code	PAL block camera	NTSC block camera	Power supply 230Vac	Power supply 24Vac	Wiper	Encoders for positioning feedback
UPT1SVSA000E			•			
UPT2SVSA000E				•		
UPT1SVWA000E			•		•	
UPT2SVWA000E				•	•	
UPT1SVCA000E			•			•
UPT2SVDA000E				•	•	•
UPT1PVSA000E	•		•			
UPT2PVSA000E	•			•		
UPT1PVWA000E	•		•		•	
UPT2PVWA000E	•			•	•	
UPT1NVSA000E		•	•			
UPT2NVSA000E		•		•		
UPT1NVWA000E		•	•		•	
UPT2NVWA000E		•		•	•	
UPT2PVDA000E	•			•	•	•

TECHNICAL DATA

GENERAL

Constructed from aluminium and ABS
 Epoxypolyester powder painting, RAL9002 colour
 Top mount (OTT)
 Transmission through toothed belt
 Slip-ring
 Electronic limit switches
 Plug installation thanks to connector and easy replacement on-site
 Zero backlash
 Supplied with instruction manual

MECHANICAL

3 cable glands M16
 Horizontal continuous rotation
 Vertical rotation +90° to -40°
 Variable pan speed from 0.02° up to 100°/s
 Variable tilt speed from 0.02° up to 40°/s
 Internal usable area: see drawings
 Enclosure glass window (WxH): 118x75mm (4.6x2.9in)
 Preset accuracy: 0.02°

PACKAGE							
Code	Unit weight		Package weight		Package dimensions (WxHxL)		Master carton
	kg	lb	kg	lb	cm	in	unit
UPT1SVSA000E	16.3	35.9	19.5	43.0	66.0x33.0x57.0	26.0x13.0x22.5	-
UPT1SVWA000E	16.8	37.0	20.0	44.1	66.0x33.0x57.0	26.0x13.0x22.5	-

ELECTRICAL/VIDEO

Input voltage:
 • 230Vac, 50/60Hz, 100W
 • 24Vac, 50/60Hz, 100W
 • 120Vac, 50/60Hz, 100W

Absorbed current:
 • 230Vac, 0.4A
 • 24Vac, 4A
 • 120Vac, 0.8A

Dimensions of input cables: AWG 16 (24Vac) -18 (120/230Vac)

Dimensions of signal cables: AWG 20-26

Housing standard heater 24Vac, 20W max

Alarm input: 10-35Vdc

Dry contacts: max 50Vdc or 30Vac @ 1A

Video line: coaxial cable (1Vpp, 750hm)

Camera power supply: 12Vdc, 800mA

Lens power supply: 6-15Vdc, max 200mA

Only polarity inversion lenses

Autopan, Preset, Patrol

250 max preset selectable (VIDEOTECH MACRO Protocol)

20 characters string for Area and Preset titling

COMMUNICATIONS

Configuration through OSD

RS232 interface for PC control set-up and firmware upgrade

2 RS485 ports for daisy chain configuration

Addressable through dip-switch up 255 units

PROTOCOLS

AMERICAN DYNAMICS, PELCO D, VIDEOTECH MACRO, VISTA

AMERICAN DYNAMICS, PELCO, VISTA are registered trademarks.

The product may be interfaced with devices not manufactured by VIDEOTECH. It is possible that the interface protocols have changed or are in a different configuration from earlier tested units by VIDEOTECH. VIDEOTECH recommends a test prior to installation. VIDEOTECH will not be liable for any installation costs or lost revenues in the event a compatibility problem will occur.

ENVIRONMENT

Indoor / Outdoor

Operating temperature with heater: -20°C / +60°C (-4°F / +140°F)

Operating temperature with reinforced heater: -30°C / +60°C (-22°F / +140°F)

Wind resistance:

- Operational: up to 160km/h (99.4mph)
- Stationary: up to 210km/h (130.5mph)

Resistant to salty fog (EN50130-5 and EN60068-2-52)

Surge immunity: up to 2KV line to line, up to 4KV line to earth (Class 4)

CERTIFICATIONS

CE EN60950-1, EN61000-6-3 and EN50130-4
 FCC part 15, Class B
 IP66 EN60529
 UL listed
 UL Canadian Safety Standards listed
 NEMA 4X

ACCESSORIES

UPTHT1	Reinforced heater for low temperatures, 30W
UPTJBUL	Junction weatherproof box for cables connexion (according UL norm)
UPT5WAS01C	Tank 5l (1,3gal) 230Vac washer pump, delivery up to 5m (16.4ft)
UPT5WAS02C	Tank 5l (1,3gal) 24Vac washer pump, delivery up to 5m (16.4ft)
UPTWAS01C	Tank 23l (6gal), IN 230Vac washer pump, delivery up to 5m (16.4ft)
UPTWAS02C	Tank 23l (6gal), IN 24Vac washer pump, delivery up to 5m (16.4ft)
UPTWAS03C	Tank 23l (6gal), IN 120Vac washer pump, delivery up to 5m (16.4ft)
UPTWASM	Tank 23l, washer pump 230Vac-24Vac or 120Vac, delivery up to 11m (36ft)
UPTWASA01C	Tank 23l (6gal), IN 230Vac washer pump, high delivery up to 30m (98ft)
UPTWASA03C	Tank 23l (6gal), IN 120Vac washer pump, high delivery up to 30m (98ft)

BRACKETS AND ADAPTORS

UPTWBA	Wall bracket with internal cable channel
UPTWBTA	Parapet bracket with internal cable channel
PTCC1	Pole mount adapter for UPTWBA
WCWGC	Corner adapter for UPTWBA

RELATED PRODUCTS

ALBERT	Unit for the intelligent digital video content analysis
SM42A-SM82A	Matrix 4/8 inputs and 2 outputs
SM84B-SM164B	Matrix 8/16 inputs and 4 outputs
SM328B	Matrix 32 inputs and 8 outputs
DCJ	Keyboard to control matrix, multiplexers and telemetry equipped with three axis joystick
DCT	Touch screen keyboard to control matrix, multiplexers, DVRs and telemetry equipped with three axis joystick
DCZ	USB keyboard for management of CCTV applications from PC

CAMERA SONY DAY/NIGHT 36X		
	PAL	NTSC
Optical zoom	36x	
Wide Dynamic Range (Fix/Auto)	•	
Progressive SCAN	•	
Digital image stabilisation	•	
White balance	Auto, ATW, Indoor, Outdoor (Fix/Auto), Sodium Vapor Lamp (Fix/Auto)	
High horizontal resolution	Up to 550 TV Lines	
Day-Night (Auto ICR)	•	
Image Sensor	1/4" EXView HAD CCD	
Number of effective Pixels	~ 440000 pixel	~ 380000 pixel
Min. night Illumination (ICR ON) (typical)	0.01 Lux / 1/3s	0.01 Lux / 1/4s
Min. day Illumination (ICR OFF) (typical)	0.1 Lux / 1/3s	0.1 Lux / 1/4s
"Shutter Time" automatic increase to improve the night surveillance	•	
S/N ratio	More than 50dB	
AE control	Auto, Shutter priority, Diaphragm priority, Brightness priority and Manual	
Back Light Compensation	On/Off	
Spherical masking (3D) of Privacy zones with automatic upgrade	•	
Privacy Zone Masking	On/Off (24 positions)	
Maximum number of masking blocks to be displayed	8	
Resolution of masking blocks	160x120 HxV	
Masking	Up to 15 different masking types: 14 colour types or mosaic	
Focusing System	Auto (Sensitivity: Normal, Low), Trigger PTZ, Manual	
"Smart" Lens Control	SONY Modular Automatic Lens Reset Technology	
High Zoom and Wide Horizontal Field of View Capability	•	
Optical Zoom	36x, f=3.4 (wide) to 122.4mm (tele) / F1.6 to F4.5	
Digital Zoom	12x (432x with optical zoom)	
Angle of View (A)	57.8 degrees (wide) to 1.7 degrees (tele)	
Min. Object Distance	320mm (wide) to 1500mm (tele)	
Electronic Shutter Speed	1/1 ÷ 1/10000s	

SONY is a registered trademark of SONY Corporation, Japan. EXview HAD is a registered trademark of SONY Corporation.

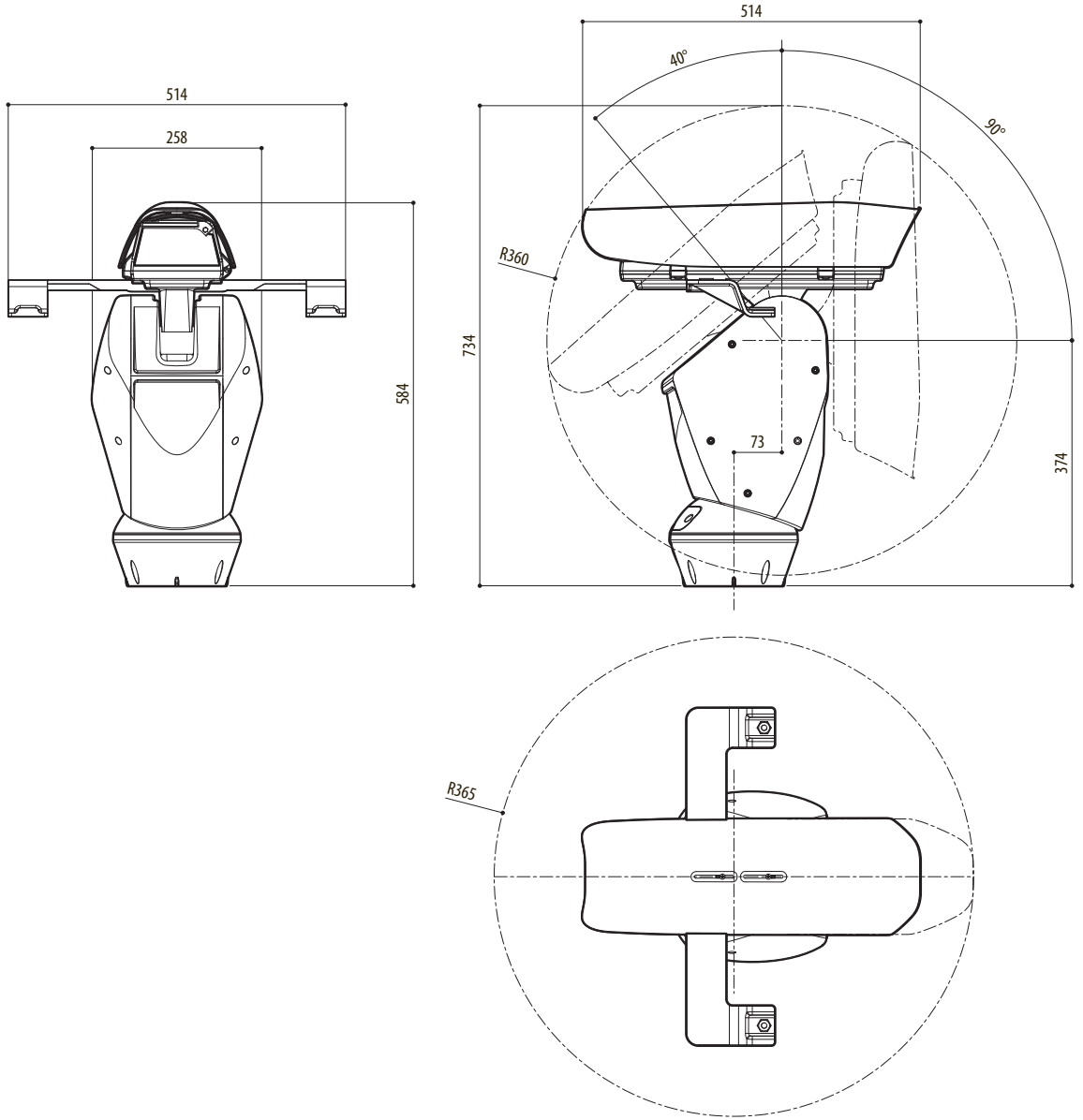

ULISSE

mm 1:10

ULISSE

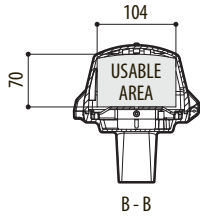
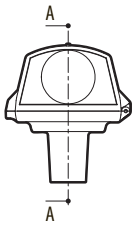

SLIDE IN STANDARD POSITION



SLIDE IN STANDARD POSITION, REINFORCED HEATER

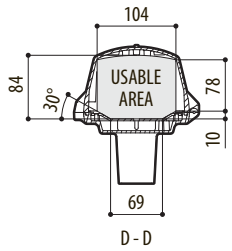
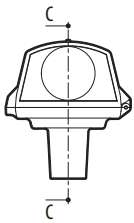
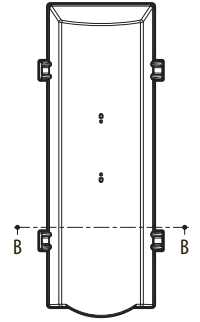
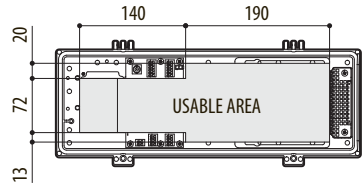
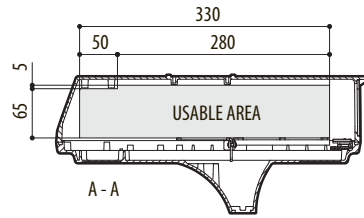

REVERSED SLIDE

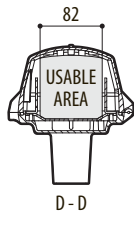

SLIDE IN REVERSED SLIDE, REINFORCED HEATER

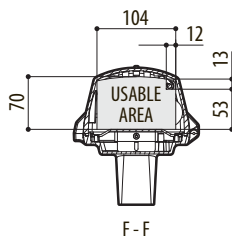
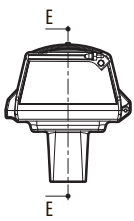
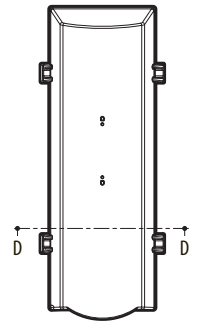
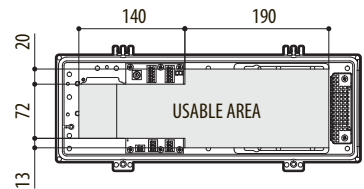
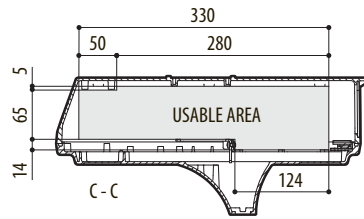

SLIDE IN STANDARD POSITION, INTEGRATED WIPER

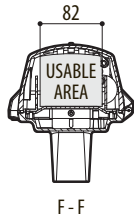

SLIDE IN STANDARD POSITION, INTEGRATED WIPER, REINFORCED HEATER

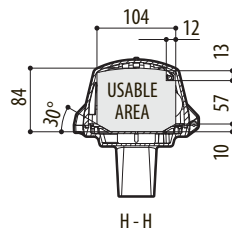
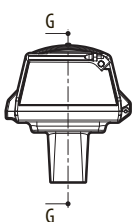
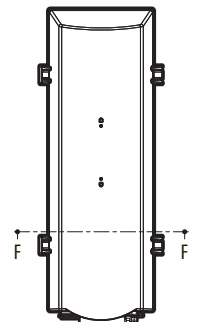
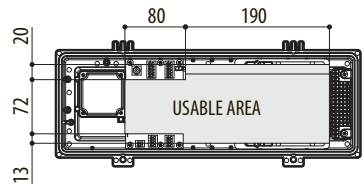
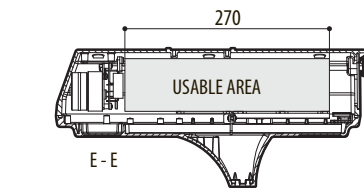

REVERSED SLIDE, INTEGRATED WIPER

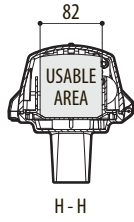

REVERSED SLIDE, INTEGRATED WIPER, REINFORCED HEATER

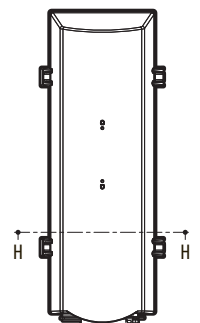
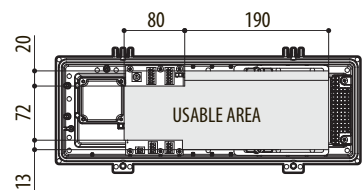
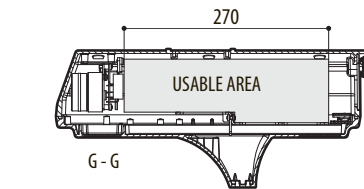

HOUSING

mm 1:10