

# 2 DOME ENCLOSURES BRACKETS

REVISION 0945



## MAIN FEATURES

Indoor and outdoor installations

## DESCRIPTION

### DBH03

Ceiling bracket for DBH24 dome enclosures. It is designed to provide a cable managed solution.

### DBH04

Wall bracket for DBH24 dome enclosures. It is designed to provide a cable managed solution. Compatible with corner and pole adapters.

### DBH05

Bracket for DBH24 dome installation on parapet and over roofs. It is designed to provide a cable managed solution.

### DPTCH1

Pole adapter compatible with DBH04 brackets.

### DBHWGC

Pole adapter compatible with DBH04 brackets for DBH24 dome installation. Colour RAL9002.

### DCWGH

Corner adapter compatible with DBH04 brackets.



DBH03



DBH04



DBH05



DPTCH1



DBHWGC



DCWGH

AVAILABLE MODELS			
Code	Wall	Ceiling	Parapet
	DBH04	DBH03	DBH05
Dome enclosures			
DBH24	•	•	•
Adapters			
DPTCH1	•		
DBHWGC	•		
DCWGH	•		

DOME ENCLOSURES BRACKETS

TECHNICAL DATA

GENERAL

Constructed from steel tube (DBH04, DCWGH, DBHWGC)  
 Constructed from aluminium tube (DBH03, DBH05, DPTCH1)  
 Epoxypolyester powder painting, black colour (white for DBHWGC)  
 Enclosure attachment with a single screw (DBH03 and DBH04)

MECHANICAL

DBH03

Internal cable management  
 Max load: 25kg (55lb)  
 Length: 922mm (36.2in)

DBH04

Internal cable management  
 Max load: 25kg (55lb)  
 Length: 357.5mm (14in)

DBH05

Installation over parapets  
 Internal cable management  
 Max load: 25kg (55lb)  
 Length: 812.5mm (31.9in)

DPTCH1

Pole installation  
 Max load: 50kg (110lb)  
 Pole diameters: 80 - 150mm (3.1 - 5.9in)  
 Compatible with DBH04

DBHWGC

Pole installation  
 Max load: 25kg (55lb)  
 Pole diameters 210mm max 225mm (8.2" - 8.85")  
 Colour RAL9002  
 Compatible with DBH04

DCWGH

Installation on corners  
 Max load: 50kg (110lb)  
 Compatible with DBH04

ENVIRONMENTS

Indoor / Outdoor

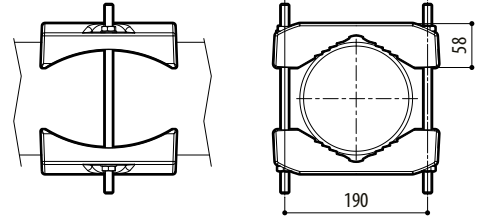
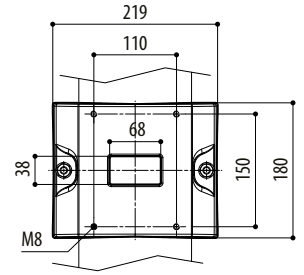

DPTCH1

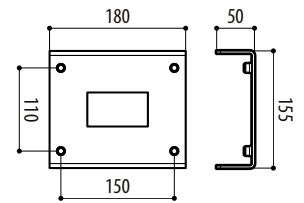

DBHWGC

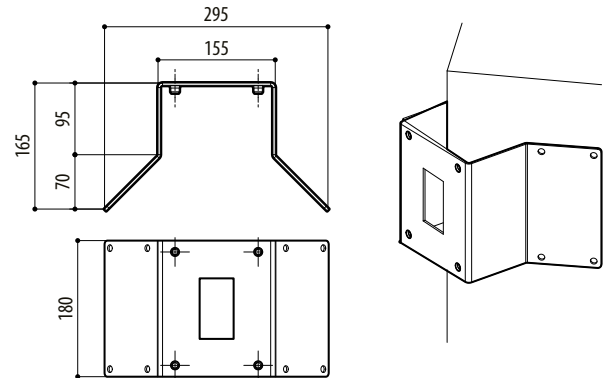

DCWGH

mm 1:10

PACKAGE

Code	Unit weight		Package weight		Package dimensions (WxHxL)		Master carton unit
	kg	lb	kg	lb	cm	in	
DBH03	2.0	4.4	2.6	5.7	9.0x19.5x105.5	3.5x7.7x41.5	-
DBH04	2.2	4.8	2.6	5.7	16.0x18.5x46.0	6.3x7.3x18.1	8
DBH05	5.0	11.0	6.6	14.5	7.5x51.0x76.0	2.9x20.0x29.9	-
DPTCH1	2.5	5.6	2.8	6.2	20.0x25.5x14.0	7.8x10.0x5.5	10
DCWGH	2.2	4.8	2.7	5.9	24.0x32.0x24.5	9.4x12.6x9.7	6

DOME ENCLOSURES BRACKETS

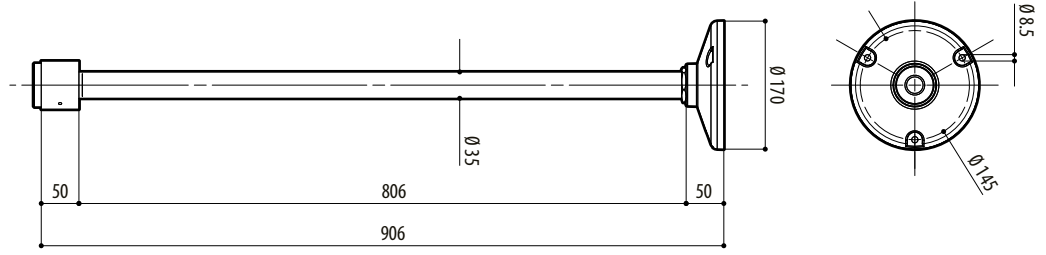

DBH03

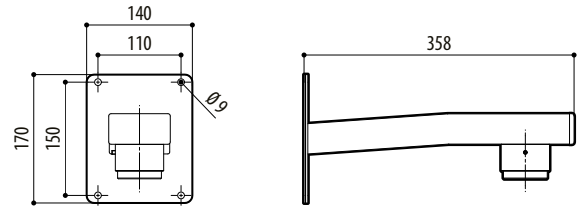

DBH04

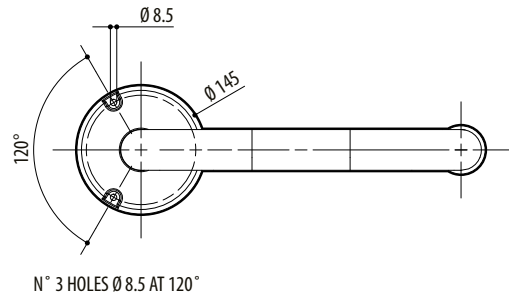
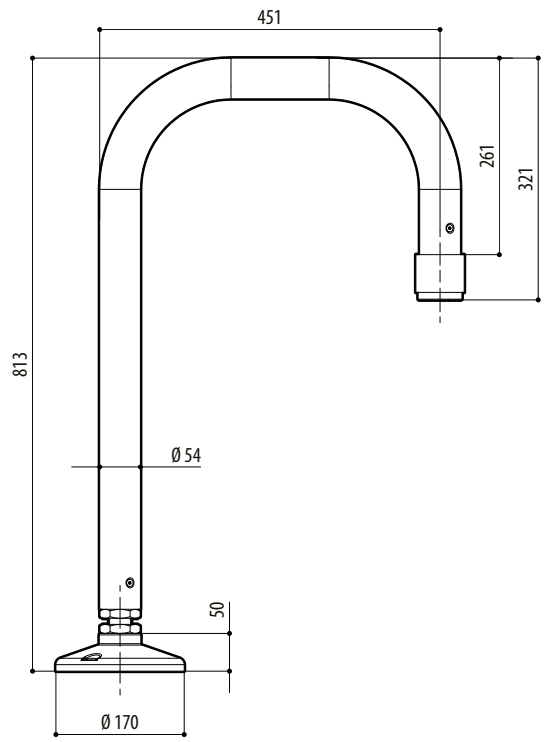

DBH05

mm 1:10

## DOME ENCLOSURES BRACKETS