

Preface

Thank you for purchasing our APB series Intelligent Controller. You are recommended to read over this manual thoroughly before operating APB series. It instructs you how to install, use and program APB, meanwhile, you will find many superior performance from it, which may facilitate the operation of APB for you.

APB series intelligent controller adopts function blocks to program and be provided with LCD display. It enables the control functions of a PLC to be achieved without the need for large number of instructions and complicated program. When several function blocks are linked together in a specific way, relatively complicated control functions can be implemented, so that the programming part will be quite simplified. Moreover, APB series can be easily connected to SH series text panel, APB-HMI operation interface, communication module, IO expansion module, voice GSM module, and compatible with MODBUS protocol.

APB series has a very wide range of applications. It can be applied to automation control of mechanical equipment, flow control, building automation control and other various fields. The application of APB series leads automation control to the everyday life of us. This manual describes in detail the functional characteristics and operation instructions about APB series.

Index

Chapter I General Introduction to APB	1
1 1 Structure of APB Series	1
1 2 Naming Rules of APB Series	2
1 3 Specifications and Type of APB	2
1 4 Features of APB	3
Chapter II Installing and Wiring of APB	5
2 1 Installing of APB	5
2 1 1 Installing Method	5
2 1 2 Installation Dimensions	5
2 2 Wiring of APB	6
2 2 1 Power Supply Connection	6
2 2 2 Input Connection	6
2 2 3 Output Connection	8
Chapter III General Description of Function Blocks	10
3 1 Logic Function Blocks LF 18 in total	10
3 1 1 AND	11
3 1 2 AND with RLO Borderline Test	11
3 1 3 OR	11
3 1 4 NOT	11
3 1 5 XOR	12
3 1 6 NAND	12
3 1 7 NAND with RLO Borderline Test	12
3 1 8 NOR	13
3 1 9 OR with Rising Edge Test	13
3 1 10 OR with Falling Edge Test	13
3 2 Special Function Block SF 18 in total	13
3 2 1 ON- delay Block TOND	15
3 2 2 OFF- delay Block TOFD	15
3 2 3 ON/OFF Delay Block TONF	16
3 2 4 Single Pulse Relay PONS	17
3 2 5 Pulse Relay Block SPBL	18
3 2 6 Clock Pulse Generator BLNK	18
3 2 7 Maintain ON Delay MTOD	19
3 2 8 RSRelay RS	20
3 2 9 Universal Counter UDCT	20
3 2 10 Up/Down Threshold Counter UDCF	21
3 2 11 Clock Switch SCHD	22
3 2 12 Time Sequence TSEQ	24
3 2 13 Step Sequence SSEQ	25
3 2 14 HOUR	27

3 2 15 T/C- CMPR CMPR	27
3 2 16 Stairway Lighting Switch STLT	28
3 2 17 Multiple Function Switch MULT	29
3 2 18 LCD Editor SLCD	29
3 2 19 Property Pin Description	29
3 3 High- speed and Analog Function Blocks: 13 in total	30
3 3 1 Frequency Threshold Trigger FTH	31
3 3 2 A+ B- Counter A+B-	32
3 3 3 Two- phase Counter 2PCT	33
3 3 4 Pulse PTO Output PTO	34
3 3 5 Pulse PWM Output PWM	35
3 3 6 Accelerate/Decelerate Single- phase Pulse Output ACC	35
3 3 7 Analog comparator CMPR	36
3 3 8 Analog Threshold Trigger THRD	38
3 3 9 Analog Amplifier AMPT	39
3 3 10 Analog Watchdog AWDT	39
3 3 11 Analog Differential Trigger WARP	40
3 3 12 Analog Multiplexer (AMUX)	41
3 3 13 Analog Math MATH	42
3 4 APB Input & Output Points: 6 in total	43
Chapter IV Instructions of APB- HMI	44
4 1 Introduction of SLCD	44
4 1 1 Introduction of Operation Interface	44
4 1 2 Edit Operation Interface	46
4 1 3 APB- HMI Application Examples	50
4 2 APB- MHI Structure and Function	56
4 2 1 APB- HMI Structure	56
4 2 2 APB- HMI Function	56
4 3 Comparison with Conventional Controller LCD	59
Chapter V APB Technical Parameters	61
5 1 APB- 22MRA Technical Parameters	61
5 2 APB- 12MRD/APB- 22MRD Technical Parameters	62
5 3 APB- 12MTD/APB- 22MTD Technical Parameters	64
5 4 APB- 12MGD/APB- 22MGD Technical Parameters	65
5 5 APB- 22ERA/APB- 22ERD/APB- 22ETD/APB- 22EGD and Extension Module Technical Parameters	66
5 6 APB series general technical parameter	72
Chapter VI APB Application	73
6 1 The Illumination of Multifunction Switch in Stairs, Halls etc	73
6 2 Automatic Gate Control	73
6 3 Illumination System for Show Windows	74
APPENDIX	
APB MODBUS RTU Introduction	76
APB- SMS Module	85
APB Communication Module Operation Guide	95

Part I Basic Operation and Application of APB

Chapter I General Introduction to APB

APB Programmable Block intelligent controller is a new type of programmable controller, being programmed by the use of Function Block Diagrams. The programming of APB is simpler and easier to learn than that of a conventional PLC, which uses ladder diagrams and associated instructions. The design concept for APB series is to program the APB series main machine and APB- HMI with the provided free program software, free from connecting to another HMI. APB- HMI is able to display the input/output status of APB series, the set value and running value of timer, counter, and analog function blocks, which facilitates the operator to monitor and control of PLC running status at real time. Currently, APB is widely used in many fields of industry, commerce, mining, agriculture, home automation etc.

1 1 Structure of APB Series

APB Main Machine Hardware Structure:

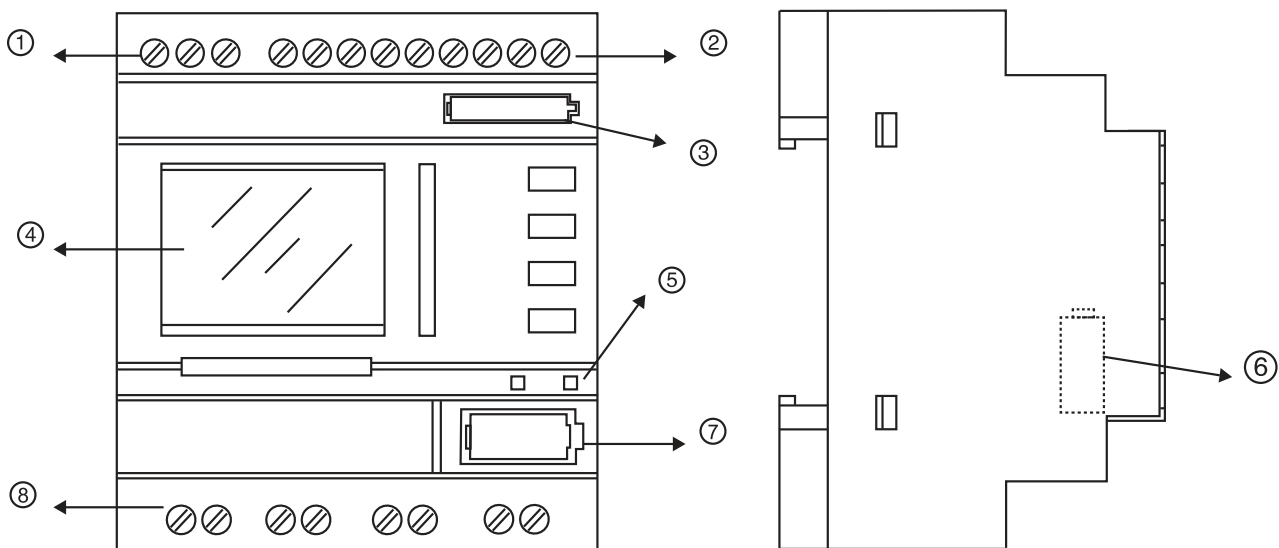
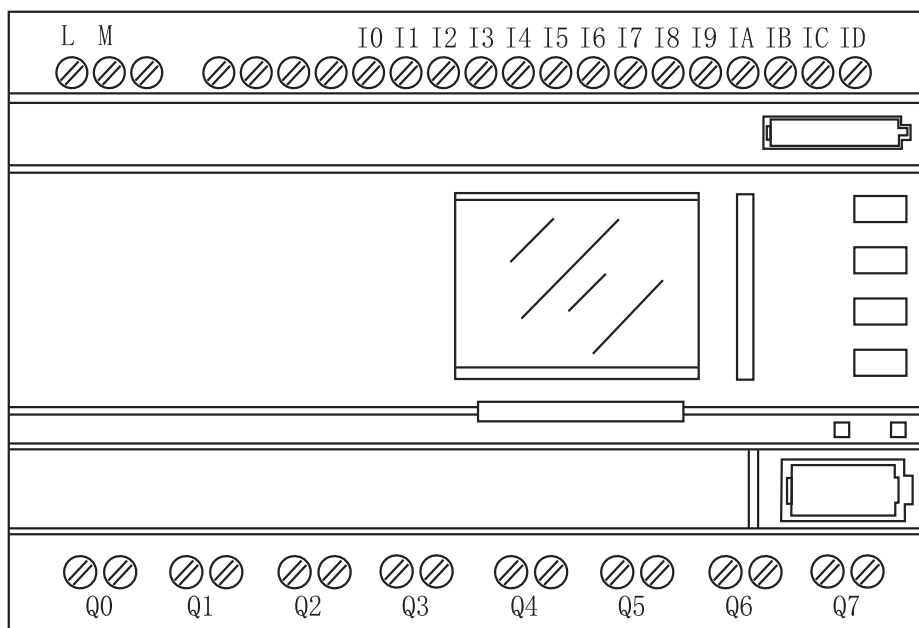

Fig. 1.1 APB- 12 Series Main Machine

- 1 Input Power AC or DC AC110- 220V DC12- 24V
- 2 Input Wiring Terminal
- 3 Real- time clock battery slot
- 4 Mini HMI APB- HMI
- 5 CPU run indicator in left \Power supply indicator in right
- 6 Extend module communication Interface
- 7 Software Communication Interface
- 8 Output Wiring Terminal Relay output type or transistor output type



APB- 22 series Main Machine

1 2 Naming Rules of APB Series

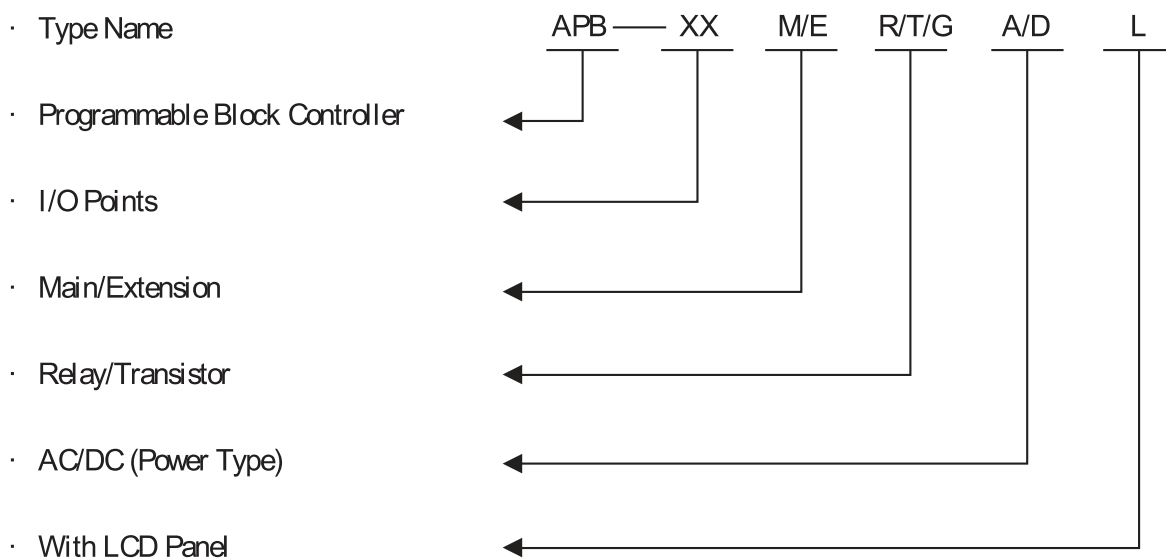

Note: M means main machine, E means extension module; R means relay output, T means NPN transistor output, G means PNP transistor output; A means AC type, D means DC type; C means real-time clock; The economical type is supplied without LCD panel, and the basic type is supplied with LCD panel.

1. 3 Specifications and Type of APB

Note: The economical type is supplied without LCD panel, and the basic type is supplied with LCD panel.			
APB- 12MRA(L)	AC110- 220V	8 points AC input	4 points relay output
APB- 12MRD(L)	DC12V- 24V	8 points digital input (can be used as analog inputs); I4- I7 can be high-speed ports	4 points relay output

APB- 12MTD(L)	DC12V- 24V	8 points digital input (can be used as analog inputs); I4- I7 can be high-speed ports	4 points NPN transistor output Q2 Q3 can be high- speed output ports
APB- 12MGD(L)	DC12V- 24V	8 points digital input (can be used as analog inputs); I4- I7 can be high-speed ports	4 points PNP transistor output Q2 Q3 can be high- speed output ports
APB- 22MRA(L)	AC100V- 240V	14 points input	8 points relay output
APB- 22MRD(L)	DC12V- 24V	14 points digital input (the first 12 points can be analog inputs); I4- I7 can be high- speed ports	8 points relay output
APB- 22MTD(L)	DC12V- 24V	14 points digital input (the first 12 points can be analog inputs); I4- I7 can be high- speed ports	8 points NPN transistor output Q2 Q3 can be high- speed output ports
APB- 22MGD(L)	DC12V- 24V	14 points digital input (the first 12 points can be analog inputs); I4- I7 can be high- speed ports	8 points PNP transistor output Q2 Q3 can be high- speed output ports
APB- 24MRD	DC12V- 24V	2points for current input, and 14points for digital input (the first 12 points can be 0~10V analog inputs); I4- I7 can be high- speed ports	6 points relay output + 2 (4- 20MA) analog outputs
APB- 22ERA	AC100V- 240V	14 points digital input	8 points relay output
APB- 22ERD	DC12V- 24V	14 points digital input	8 points relay output
APB- 22ETD	DC12V- 24V	14 points digital input	8 points NPN transistor output
APB- 22EGD	DC12V- 24V	14 points digital input	8 point NPN transistor output

Note: The type without L indicates the main machine of this type is supplied without LCD panel.

1 4 Features of APB

1 Flexible human- machine interface (APB- HMI)

If Chinese language is selected in APB software APB- SLCD will display Chinese after APB program has been downloaded from PC. If English language is selected in APB software APB- SLCD will display English after APB program has been downloaded from PC. When using APB- HMI, users can easily add SLCD function block no more than 64 according to actual needs. On the LCD, it will display the following data, such as time, status of input & output, counter, timer, analog and so on information. Moreover, it is allowed to modify, add or delete the interface during the operation.

2 Well- featured and compact design

If you are thinking of making your equipment more compact, APB would be your best choice:

71mmX90mmX58.5mm (12- point machine)

126mmX90mmX58.5mm (22- point machine)

3 Adopting the function blocks for programming, with large program storage capacity

The control functions of APB can be implemented only with function blocks incorporated into a function block diagram. The same level of control implemented by a conventional PLC would require a much larger

and more detailed program. When several function blocks are linked together in a specific way, then relatively complicated control functions can be implemented. APB's program storage capacity is up to 320 function blocks. There is a large application resource to satisfy the requirements for complicated control. Once a program is downloaded into APB, it will be retained for ever.

4 External extendable input/output

APB series main machine can be connected with the relevant APB- 22E extension module, thus it can be extended to 22 points input/output once (14 points input and 8 points output). One set main machine of APB series can be externally connected with 7 extension modules, which brings you many input/output for your control.

5 Analog input and transmission (The IA ports of DC type main machines all have the analog input function.)

In addition to receiving switching input, APB can also receive 0~10V voltage signal. 22 points main machine can receive 2 ways 4- 20mA current signal to implement the control of temperature, humidity, pressure, flow, level unit, etc., and transmit them remotely to a computer for monitoring.

6 Support high- speed input/output function

APB series PLC can support high- speed pulse counting. The range of pulse frequency is 1- 10KHZ. The output terminal (Q2, Q3) can output the pulse signal up to 10KHZ.

7 Retentivity

The retentivity function can be set flexibly. APB can save the current data in time when a power failure occurred. And it resumes operation at the break point when it is power on again.

8 Security cipher code function

APB is provided with protection for the programs downloaded into it. A security cipher code can be set before programs are written. The programs can then only be modified after the correct cipher code is entered.

9 Free Programming Software

APB software is the user- friendly human- machine interface programming software. It can edit the function diagrams and also can simulate the written program on PC. APB Software provides an off- line testing function for the user, which overcomes much of the possible inconveniences normally experienced during on- line testing.

Chapter II Installing and Wiring of APB

2 1 Installing of APB

2 1 1 Installing Method

As APB is very small, it is suitable to be installed inside. The installation of APB is quite simple:

Use a standard DIN rail for installation of APB, as it is shown in Fig



Use standard DIN rail for installation of APB

2 1 2 Installation Dimensions

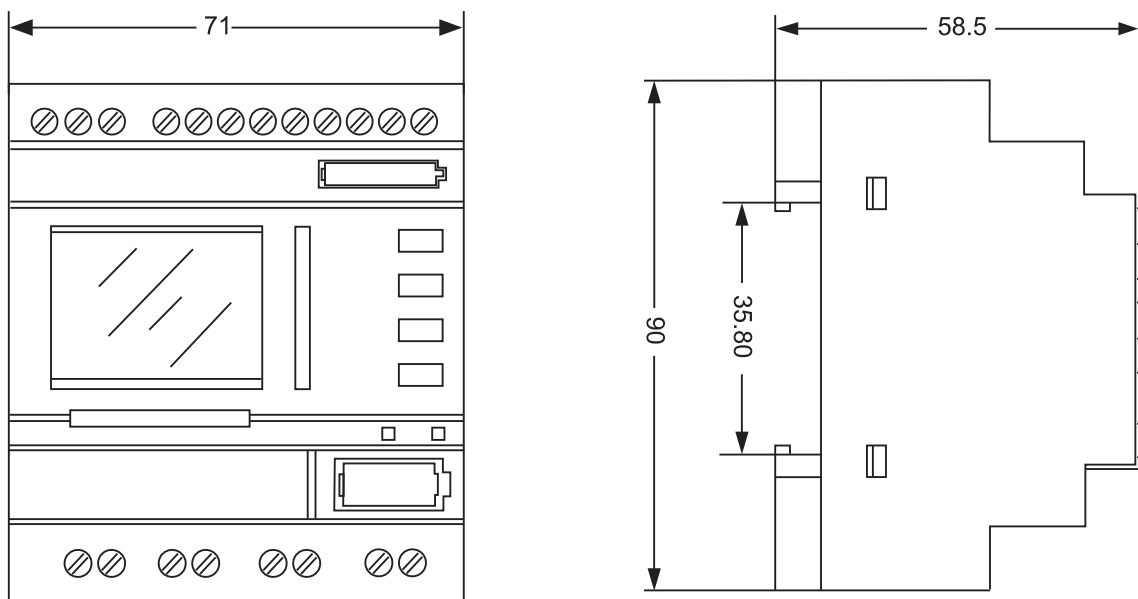

Installation Dimension of APB- 12 Series (mm)

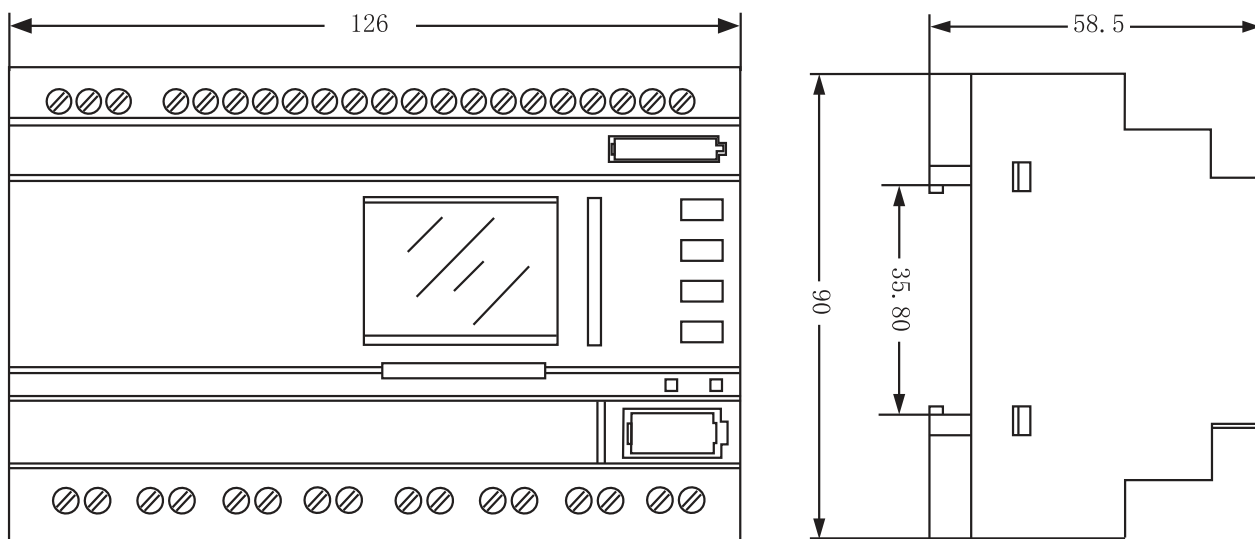

Installation Dimension of APB- 22 Series (mm)

2 2 Wiring of APB

Use a screwdriver with a spade tip of 3mm width for the wiring of APB. The size for wire cross section:
 $1 \times 2.5 \text{mm}^2$ $2 \times 1.5 \text{mm}^2$

2 2 1 Power Supply Connection

1. APB- 22M(E)RAC is AC type. The rated power supply for it is 110- 220VAC, 50/60Hz. The range of the grid voltage is between 100VAC and 240VAC. The consumption power for APB- 22M(E)RA is 5W.

2. APB- 12MRD, APB- 12MTD, APB- 22M(E)RD, and APB- 22M(E)TD are DC types. The supply DC voltage is 12VDC and 24VDC. The range of the voltage is between 12VDC and 24VDC. The consumption power for APB- 12MRD and APB- 22M(E)RD is 3W and 5W respectively, and the consumption power for APB- 12MTD and APB- 22M(E)TD both are 2W.

The power connection for APB series is shown in the following figures:

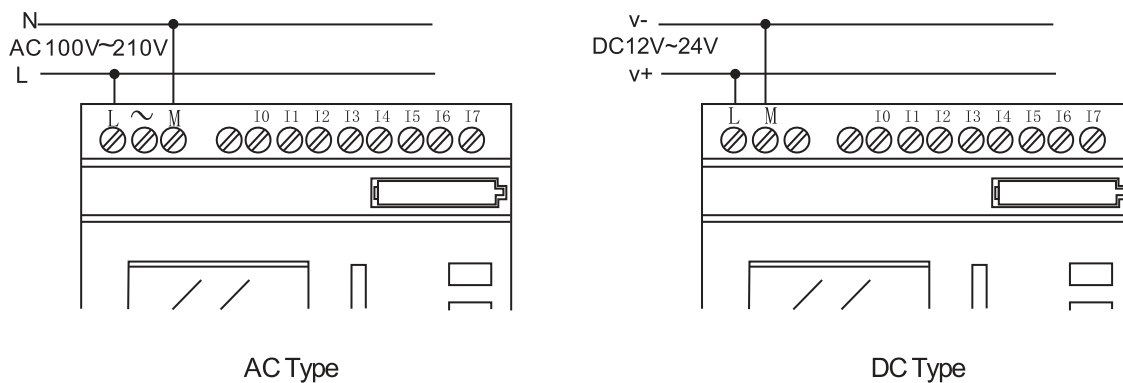

AC Type

DC Type

2 2 2 Input Connection

The input to APB can be either switching input, such as switches, fluorescent lamp switch etc., or analog input, such as pressure, temperature, humidity, flow, etc. (only for IA input port of DC type main machine). The specific requirements are shown as follows:

Demand \ Type	APB- 22MRA	APB- 12MRD APB- 22MRD	APB- 12MTD APB- 22MTD
Switch Status 0	<AC40V	<DC5V	<DC5V
Input Current	<0.24mA	<0.08mA	<0.08mA
Switch Status 1	≥ AC85V	≥ DC8.5V	≥ DC8.5V
Input Current	Typical 0.24 mA	Typical 0.15mA	Typical 0.15 mA
Analog Input	No	I00- I07/I00 I0D	I00 I07/I00 I0B

Note:

- As for APB- 12MRD, APB- 12MTD, APB- 22MRD and APB- 22MTD these can receive analog input, the analog inputs (IA) of these types can receive either analog input or digital input.
- It is necessary to have analog calibration for PLC input terminals before PLC receives analog signal. For details, please refer to analog calibration part in High- speed and Analog Function Blocks
- For Analog input, input signal is DC0V ~10V voltage signal or 4- 20mA current signal. In programming, all the block parameters related to the analog voltage inputs are based on the minimum increment 0.04V.
- When the input voltage is more than 10.0VDC, it is only can be used as switching input (or a large error will exist)As for APB- 24MRD when it receives the current signal as analog input the input current signal can not exceed 50mA or the PLC will damage.
- As for switching input, the default time for transition from 0 to 1 or from 1 to 0 is more than 50ms. The filtering duration can be set flexibly in APBsoft. The time range is 20ms~1s.

Input connection for APB series is shown as the following figures:

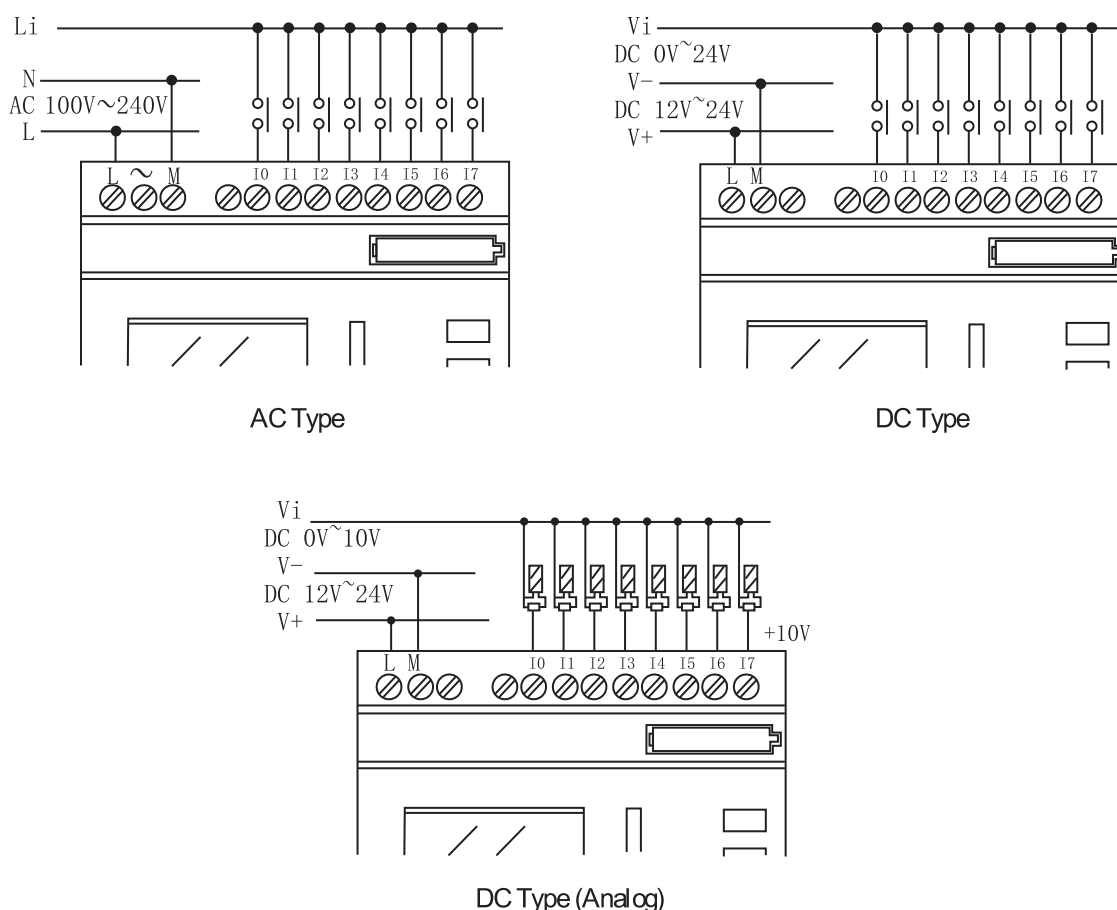

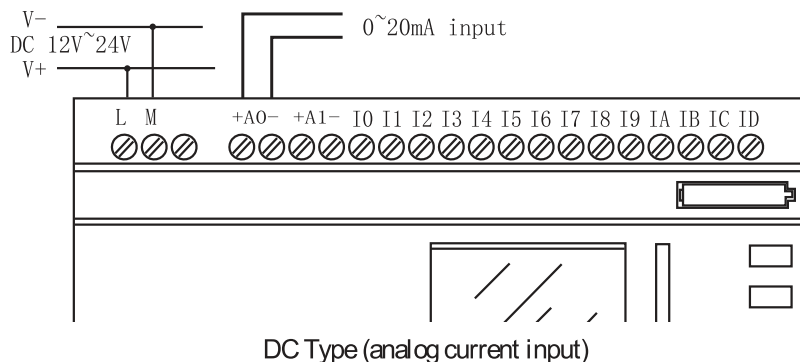

DC Type (analog current input)

2 2 3 Output Connection

1 Requirements for the relay output

Various loads such as lamp, fluorescent lamp, motor, contactor, etc., can be connected to the outputs of APB. The maximum output current supplied by APB is 10A for the resistance load and 2A for the inductive load. The connection is in accordance with the following figure:

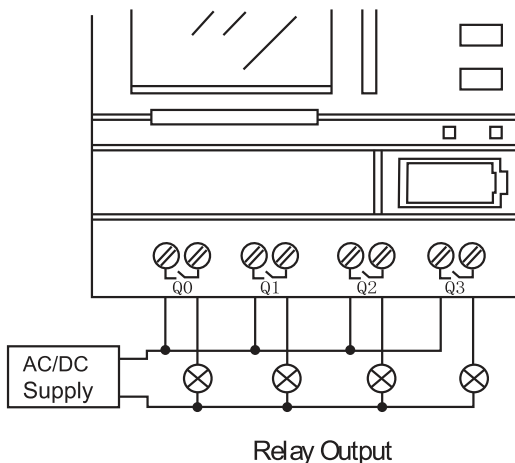

Relay Output

2 Requirements for the transistor output:

The load connected to APB must have the following characteristics:

The maximum switch current cannot exceed 2A

- When the switch is ON (Q=1), the maximum current is 2A.
- There are two types transistor: one is the NPN transistor. The connection of APB- 12MTD and APB- 22MTD is in accordance with the following figure:

The connection of APB- 12MTD and APB- 22MTD is in accordance with the following figure:

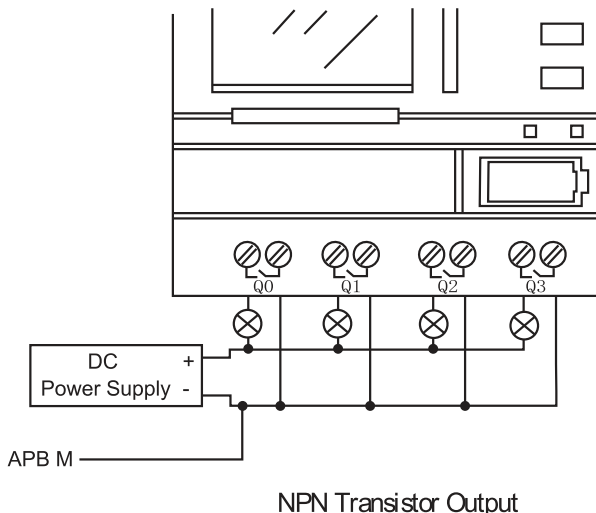

NPN Transistor Output

Notes

1. The connecting voltage must be $\leq 24\text{VDC}$ and the load voltage must be DC type.
2. The negative voltage “ - ” of the load should be connected to “ M ” terminal of APB power supply, and the load must be connected to the positive voltage “ + ” of DC power supply.

The other is equivalent PNP type, for example, APB- 12MGDC and APB- 22MGDC

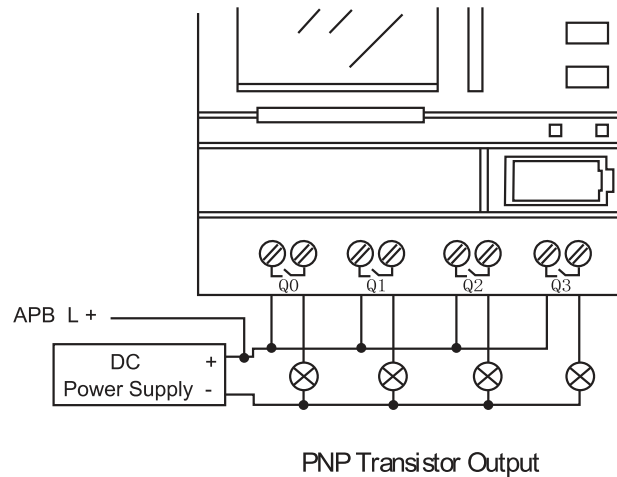

Notes

1. The connecting voltage must be $\leq 24\text{VDC}$ and the load voltage must be DC type.
2. The positive voltage “ + ” of the load should be connected to “ L+ ” terminal of APB power supply, and the load must be connected to the negative voltage “ - ” of DC power supply.

Chapter III General Description of Function Blocks

APB series adopts the function blocks to program. There are 10 basic function blocks, 18 special function blocks, 13 high-speed and analog function blocks, and 6 input/output function blocks. Each of them can achieve a specific control function independently, such as TOND, TOFD, TONF, UDCT, etc. If several blocks are linked up in a specific way, a relatively complicated control function can be realized. Programming with function blocks is simpler and better appreciated than the conventional PLC instruction programming.

Note:

In APB series, the function blocks will be executed in scan round according to the block number from small to large order. The block with small number will be executed first.. In program, the total number of timers or counters with retentivity function must be no more than 16 at most. The address for retentive register is D0~D12, and the address for retentive relay is M0~M63.

3. 1 General Function Blocks (GF), 10 in total

Table 1: General Function Blocks

Function	Line diagram	Function	Line diagram
AND		NAND	
ANDL (With RLO borderline test)		NANDL (With RLO borderline test)	
OR		NOR	
NOT		OR with rising edge test	
XOR		OR with falling edge test	

3 1 1 AND

In APB, the symbol is shown as follow:

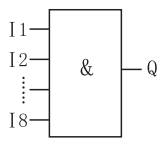

This function block is called as AND, because only when all of I1, I2, I3, I4, I5, I6, I7 and I8 are in status 1, the status of Output Q will be 1 (i.e. the output is closed). If any one of I1, I2, I3, I4, I5, I6, I7 and I8 is in status 0, the Output Q will be 0.

3 1 2 AND (With RLO borderline test)

In APB, the symbol is shown as follow:

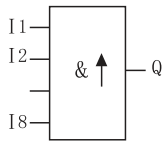

The output status of AND with RLO borderline test is 1 only when all status of the inputs is 1 and at least one input status is 0 in the last period.

The time diagram of AND with RLO borderline test is shown as follow:

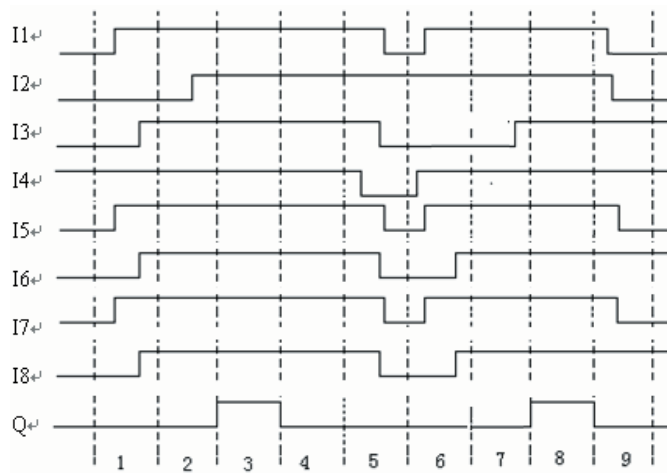
**3 1 3 OR**

In APB, the symbol is shown as follow:

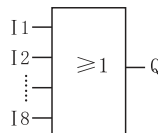

This function block is called as OR, because at least one input status of inputs I1, I2, I3, I4, I5, I6, I7 and I8 is 1 (i.e. closed), then output Q is 1.

3 1 4 NOT

The phase inverter is indicated in APB line diagram:

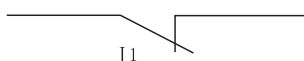

The symbol of NOT is shown as follow:

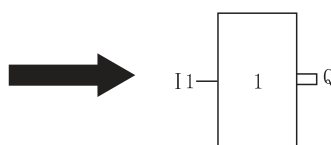

This function block is called as NOT, because if the input status is 0, output Q is 1, and vice versa. In other words, NOT is the phase inverter for the input point.

3 1 5 XOR

As shown in the line diagram, the two are is shown as follow:

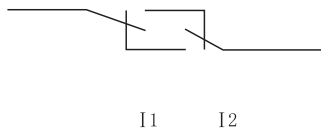

In APB, the symbol of XOR commutator contacts for XOR connected in series:

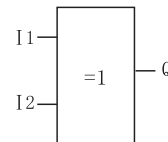

When the status of inputs is different, the output status of XOR is 1.
When the status of inputs is the same, the output status of XOR is 0.

Logic frame of XOR:

I1	I2	Q
0	0	0
0	1	1
1	0	1
1	1	0

3 1 6 NAND

In APB, the symbol is shown as follow:

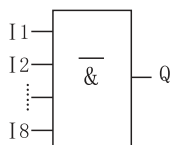

When all the status of I1 I2 I3 I4 I5 I6 I7 I8 is 1 at the same time, the output Q is 0.

When the status of I1 I2 I3 I4 I5 I6 I7 I8 is not 1 at the same time, the output Q is 1.

3 1 7 NAND with RLO borderline test

In APB, the symbol is shown as follow:

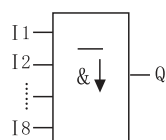

The output status of this NAND with RLO borderline test is 1 only when at least one input status is 0 and all status of inputs in the last period is 1.

Time diagram of NAND with RLO borderline test is shown as follow:

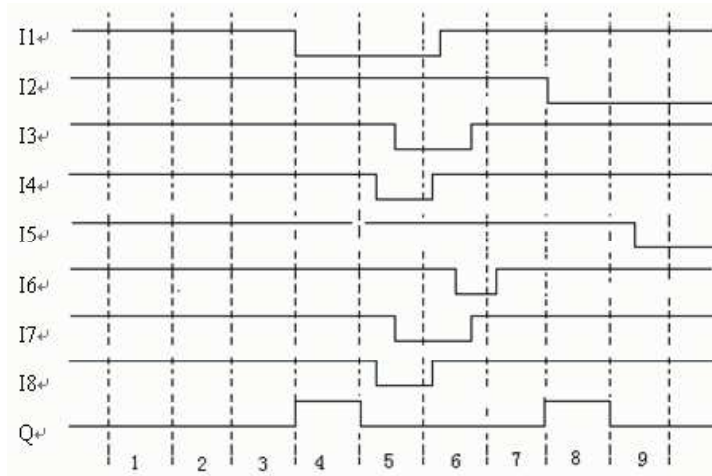

3 1 8 NOR

In APB, the symbol is shown as follow:

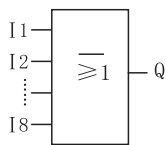

In NOR function block, when the status of all inputs is low potential (status 0), the output is connected (status 1). If any one of the input is high potential (status 1), the output is opened (status 0).

3 1 9 OR with rising edge test

In APB, the symbol is shown as follow:

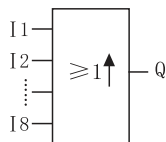

When at least one input status is changed from 0 to 1, the output is 1.

3 1 10 OR with Falling Edge Test

In APB, the symbol is shown as follow:

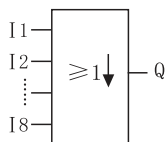





When at least one input status is changed from 1 to 0, the output is 1.

3 2 3 2 Special Function Blocks: 18 in total

Table 2: Special Function Blocks

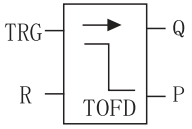
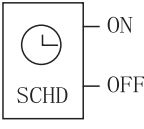
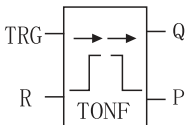
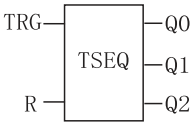
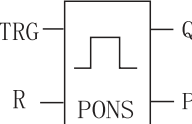
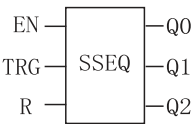
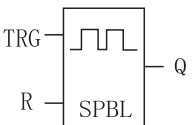
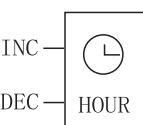
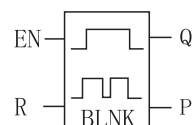
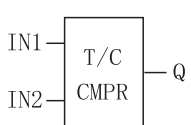
Function	Line diagram	Function	Line diagram
ON delay TOND		Up/Down threshold counter UDCT	

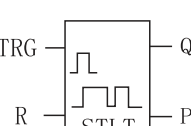
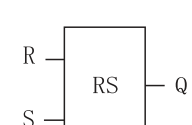
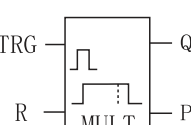
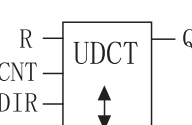
Renewal Table 2: Special Function Blocks

Function	Line diagram	Function	Line diagram
OFF delay TOFD		Scheduer switch SCHD	
ON/OFF delay TONF		Time sequence output (TSEQ)	
Program ONE SHOT PONS		Step sequence output SSEQ	
Single Pushbutton Latch SPBL		Clock adjust HOUR	
Blinker relay BLNK		Timer/counter comparator T/C- CMPR	
Delay Maintain ON MTOD		Stairway lighting switch STLT	
RSrelay TPBL		Multiple function switch MULT	
Universal counter UDCT		LCD editor (SLCD)	

3 2 1 ON-delay Block (TOND)

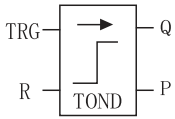
Line diagram/ Symbol in APB	Pin	Description
	Input TRG	After TRG is triggered, the time delay timer starts timing. (If TRG stops triggering during the timing, the timer will terminate the timing.)
	Input R	A signal at input R (reset input) resets the on- delay timer, and sets the output Q to be 0 (R takes priority over TRG).
	Output Q	If there is still trigger signal when time T is up, the output Q will be on.
	Output P	Outputs the running value of the block to the Register D.

Parameter Setting

The unit of time T can be set as hours: minutes: seconds: milliseconds, and the range of value is 00:00:00- 01 0~999:59:59- 990. The timing accuracy can reach 0.5% .

Time Sequence Frame:

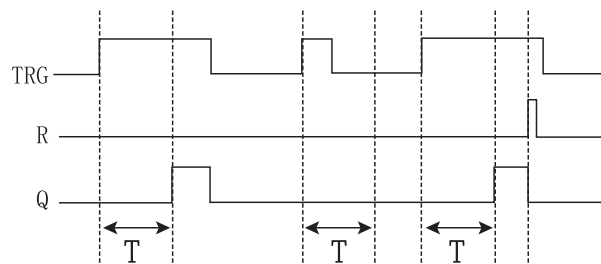

Functional Description:

1. When the status of TRG changes from 0 to 1, the time delay timer starts timing. If TRG holds the status 1 for a sufficiently long time, the output will be changed to 1 after the time T has elapsed. There is a time delay between the input turning ON and the output turning ON, and that is why the TOND is so called.
2. If the status of TRG input changes into 0 before the fixed time, the timer will be reset.
3. When the status of TRG input is 0, then the output is reset to 0.
4. This function is applicable to overriding vibrations of switches, delayed start- up of motor, delayed turning- on of lights, etc.
5. Retentivity function is optional.

3 2 2 OFF Delay Block (TOFD)

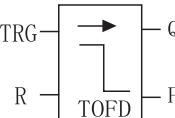
Line diagram/ Symbol in APB	Pin	Description
	Input TRG	Turn on the timer of the off- delay relay, when the input TRG (trigger) is at the descending edge (changing from 1 to 0).
	Input R	The time of the off- delay relay is reset via R (Reset Input), and Output Q is set to 0. (R takes priority over TRG.)
	Output Q	Input TRG is activated, then the output is turned on (Q=1) and is kept ON until it is reset when the set time T is up.
	Output P	Outputs the running value of the block to the Register D.

Parameter Setting

The unit of time T can be set as hours: minutes: seconds: milliseconds, and the range of value is 00:00:00- 01 0~999:59:59- 990. The timing accuracy can reach 5ms.

Time Sequence Frame:

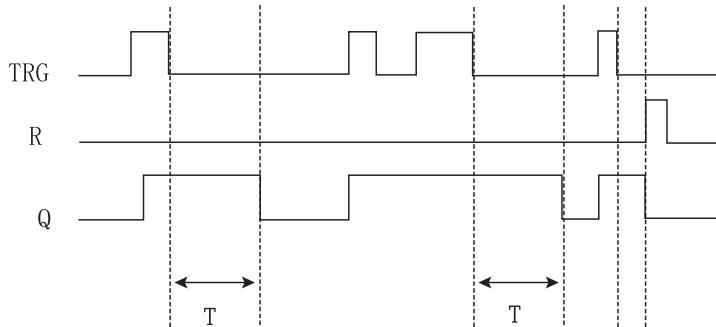

Functional Description:

- 1 When Input TRG is Status 1, Output Q is changed at once to Status 1. When Input TRG is changed from 1 to 0 (when the descending edge comes), the internal time delay timer of APB is activated and Output Q is still remained in status 1. When the set time T is up, Output Q becomes 0 and the timer is reset.
- 2 If Input TRG changes from Status 1 to Status 0 again, the timer is activated again.
- 3 Before the set time T is up, the timer and output can be reset via R (Reset) input
- 4 This function is applicable to the lighting of staircase, the control of barriers in a car park, the control of the water throttling valve, etc.
- 5 Retentivity function is optional.

3 2 3 ON/OFF Delay (TOFD)

Line diagram/ Symbol in APB	Pin	Description
	Input TRG	A positive edge (0 to 1 transition) at input Trg (Trigger) triggers the on- delay time TH. A negative edge (1 to 0 transition) at input Trg (Trigger) triggers the off- delay time TL.
	Input R	A signal at input R (reset input) resets the on/off- delay timer, and sets the output Q to 0 (R takes priority over TRG).
	Output Q	Q is set if Trg is still set as 1 when there is a 0 to 1 signal transition at input Trg, and the configured time TH has expired. It is reset on expiration of the time TL, if there is a 1 to 0 signal transition at input Trg (Trigger).
	Output P	Outputs the running value of the block to the Register D.

Parameter Setting

The unit of time T can be set as hours: minutes: seconds: milliseconds, and the range of value is 00:00:00- 01 0~999:59:59- 990. The timing accuracy can reach 0.5% .

Time Sequence Frame:

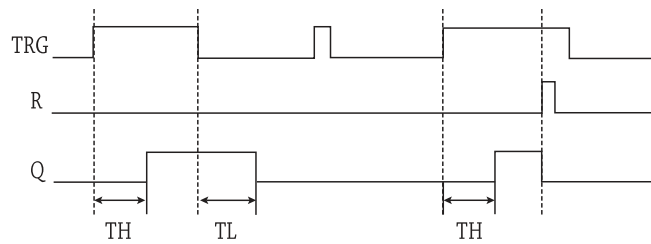

Functional Description:

- 1 The time TH is triggered with a 0 to 1 transition at input Trg.
- 2 If the status at input Trg is 1 at least for the duration of the time TH, the output is set to 1 after the time TH has expired (the output follows the input after on- delay time).
- 3 The time is reset when the signal at input Trg is reset to 0 before the time TH has expired.
- 4 A 1 to 0 transition at input Trg triggers the time TL.
- 5 If the status at input Trg is 0 at least for the duration of the signal TL, the output is set to 0 after the time TL has expired (the output follows the input after off- delay time).
- 6 The time is reset when the signal at input Trg changes to 1 again before the time TL has expired.

3 2 4 Program ONE SHOT PONS

Line diagram/ Symbol in APB	Pin	Description
	Input TRG	Input TRG activates the single- pulse time and relay. When the ascending edge arrives, it will output a pulse with the width of T.
	Input R	Reset Single- pulse time relay. When R is 1, the Output Q changes to 0.
	Output Q	Every time TRG changes from 0 to 1, the Q outputs a pulse with the width of T.
	Output P	Outputs the running value of the block to the Register D.

Parameter Setting

The unit of pulse width T can be set as hours: minutes: seconds: milliseconds, and the range of value is 00:00 :00- 010~999:59:59- 990. The timing accuracy can reach 0.5‰ .

Time Sequence Frame:

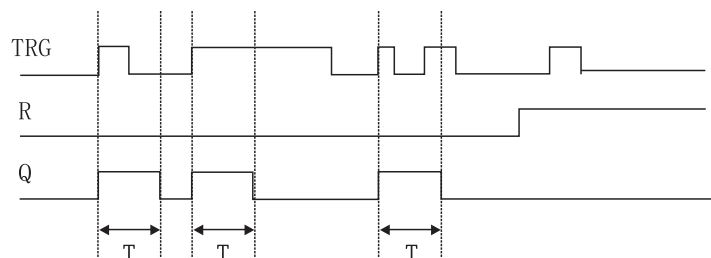

Functional Description:

1. When Q is 1, TRG pulse has no effect on Output Q.
2. Retentivity function is optional.
3. This function is applicable to change the pulse width.

3 2 5 Single Pushbutton Latch SPBL

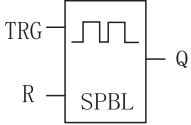
Line diagram/ Symbol in APB	Pin	Description
	Input TRG	Trigger input (TRG) makes the output ON and OFF.
	Input R	The output Q is reset via R (Reset Input). (Q=0, R takes priority over TRG.)
	Output Q	Every time TRG changes from 0 to 1, the status of Q will be changed (i.e. from Status 0 to Status 1 or vice versa).

Time Sequence Frame:

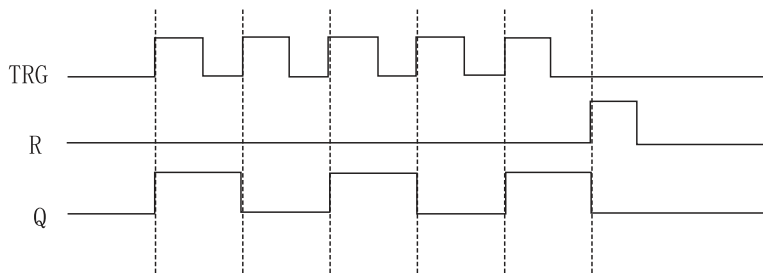

Functional Description:

- 1 Every time the trigger input TRG changes from Status 0 to Status 1, the status of Output Q will change accordingly (The status of Q will be reversed).
- 2 Reset Q to Status 0 via Input R.
- 3 After the power is ON or OFF, the pulse relay is reset and Output Q changes to 0.
- 4 If the status of TRG is being Status 1 from the start, it can be regarded as the ascending edge from the start.
- 5 This function is applicable to the lighting of staircase .the control of motor startup and stop with single push button

3 2 6 Blinker relay BLNK

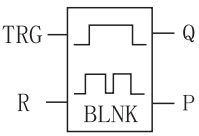
Symbol in APB	Pin	Description
	Input TRG	When the ascending edge arrives at TRG and keeps the high potential, a pulse is output according to the time width between ON and OFF.
	Input R	Make Output Q be 0 via Input R (Reset).
	Output Q	Every time TRG changes from 0 to 1, and keep 1 status, the Output Q is 1, and when Time TH is up, the output becomes 0. It becomes 1 again when the Time TL has expired. The cycle operation is continued in this way until TRG is 0 and Output Q is 0. After R becomes 1, the output Q is 0. And when R changes from 1 to 0, all status will change cyclically depends on the input status.
	P Output	Outputs the running value of the block to the Register D.

Parameter Setting

Time parameter; TH indicates the duration of output ON; and TL indicates the duration of output OFF.

The time unit can be set as hours: minutes: seconds: milliseconds, and the range of value is 00:00:00- 010~999:59:59- 990. The timing accuracy can reach 0.5‰ .

Time Sequence Frame:

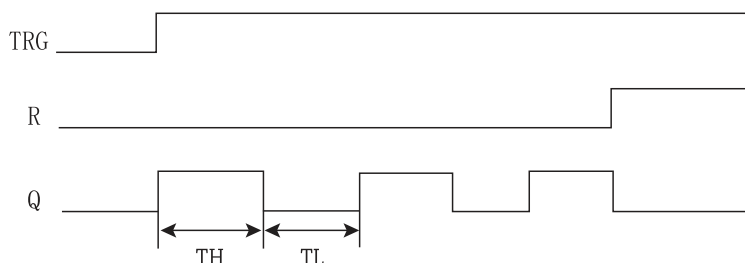

Functional Description:

Input EN enables the clock pulse generator to work. Output Q of clock pulse generator will be ON time TH and OFF time TL and cycle operation is continued in this way until Input En is 0. The clock pulse generator then stops operation and Output Q is 0.

3 2 7 Delay Maintain ON MTOD

Symbol in APB	Pin	Description
	Input TRG	Timer for ON time delay is started via Input TRG (Trigger).
	Input R	Input R resets the timer for ON time delay, and makes Output Q be 0. (R takes priority over TRG.)
	Output Q	After time delay T elapses, the output is ON.
	Output P	Outputs the running value of the block to the Register D.

Parameter Setting

The unit of time T can be set as hours: minutes: seconds: milliseconds, and the range of value is 00:00:00- 010~999:59:59- 990. The timing accuracy can reach 0.5‰ .

Time Sequence Frame:

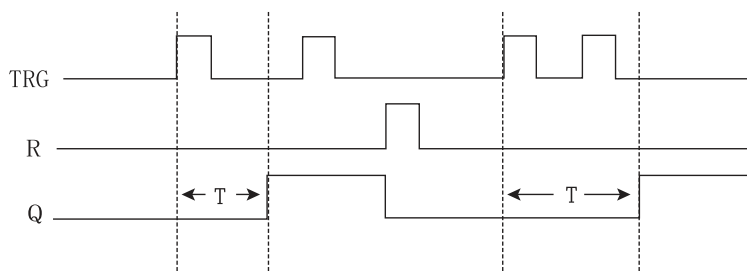

Functional Description:

- 1 If the status of Input TRG changes from 0 to 1, the internal timer will be activated. When time T is up. Output Q becomes 1 and then the Input TRG coming again has no effect on output Q. Output Q and Timer T will be reset to 0 only when Input R becomes 1 again.

- 2 This function is applicable to the occasions where the On- delay and hold- ON status are required.
- 3 Retentivity function is optional.

3 2 8 RSRelay (RS)

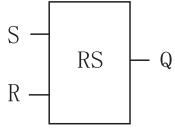
Symbol in APB	Pin	Description
	Input S	Make the Output Q in status 1 with Input S (Set).
	Input R	The Output Q is reset to 0 with R (Reset Input). If S and R are both in status 1, Output Q is 0 (R takes priority).
	Output Q	When S is the Input, Q turns and maintains ON. It will be reset till Input R is set.

Functional Description:

RS Relay is a simple trigger with two values. The output value is decided by the input status and the original output status. The following table can explain the logic relationship between them:

S	R	Q	Remarks
0	0		The status maintains the original value
0	1	0	Reset
1	0	1	Set
1	1	0	Reset (Reset takes priority over Set.)

3 2 9 Up/Down counter UDCT

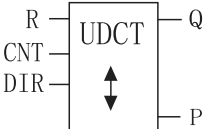
Line diagram/ Symbol in APB	Pin	Description
	Input R	Internal counter value and the output are reset via R (Reset). (R takes priority over CTN.)
	Input CNT	Optional counter mode 1. Rising edge counter When rising edge counter mode is chosen The counter just counts the change from status 0 to status 1 and doesn't count the change from status 1 to status 0 2. Descending edge counter When descending edge counter mode is chosen The counter just counts the change from status 1 to status 0 and doesn't count the change from status 0 to status 1
	Input DIR	Specifies the direction of the counter with Input DIR (Direction) DIR=0 Counting up DIR=1 Counting down
	Output Q	When the counting value is reached, the Output is ON.
	Output P	Outputs the running value of the block to the Register DW.

Parameter Setting

The range for counter parameter: 0~99999999

Time Sequence Frame is shown as follow when PAR=5:

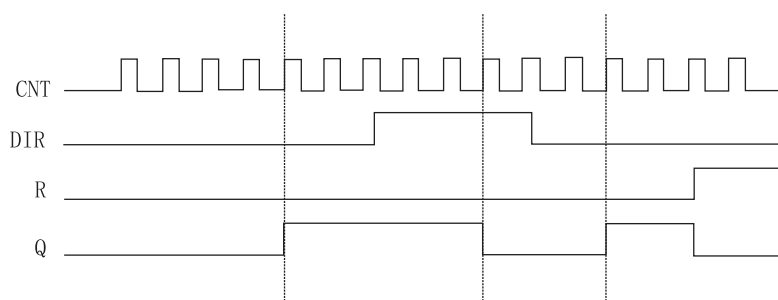

Functional Description:

1. Every time when a rising edge is input at CNT, the internal counter adds 1 (DIR=0) or minus 1 (DIR=1). If the value of internal counter is larger than or equal to parameter value PAR, the output Q is set to 1.
2. If Reset R is input as 1, the internal counter and output will be reset to 0. If R=1, output Q is 0, and then does not count Input CNT.
3. choose counting rising edge or descending edge in function block property
4. Retentivity function and high- speed running function are optional.

Notes

1. The counting frequency is related to filtering duration. If the default filtering duration is 50ms, please choose high- speed running mode when input frequency exceeds 4HZ.
2. I4~I7 are high- speed inputs. Each high- speed input only can be connected with a function block of high- speed counting in a program.

3 2 10 Up / Down Threshold Counter UDCF

Line diagram/ Symbol in APB	Pin	Description
	R Input	A signal at input R(reset) resets the internal count value and output (R takes priority over CNT).
	TRG Input	Optional counter mode 1.Rising edge counter When rising edge counter mode is chosen The counter just counts the change from status 0 to status 1 and doesn' t count the change from status 1 to status 0 2.Descending edge counter When descending edge counter mode is chosen The counter just counts the change from status 1 to status 0 and doesn' t count the change from status 0 to status 1
	DIR Input	Specifies the direction of counter with Input DIR(direction): DIR=0: Counting up DIR=1: Counting down
	Q Output	Q is set or reset, depending on the current value at CNT and the set thresholds.
	P Output	Outputs the running value of the block to the Register DW.

Parameter Setting

- on On threshold Range of values: 0- 99999999
- off Off threshold Range of values: 0- 99999999

Time Sequence Frame

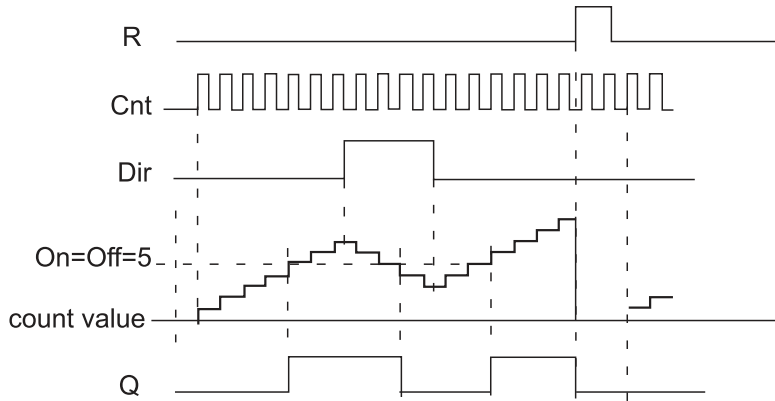

Functional Description:

1. If the On threshold \geq Off threshold, then: when $Cnt \geq On$, $Q=1$, when $Cnt < Off$, $Q=0$,
2. If the On threshold $<$ Off threshold, then: when $On \leq Cnt < Off$, $Q=1$
3. Retentivity function and high- speed running function are optional.

Notes

1. The counting frequency is related to filtering duration. If the default filtering duration is 50ms, please choose high- speed running mode when input frequency exceeds 4HZ.
2. I4~I7 are high- speed inputs. Each high- speed input only can be connected with a function block of high- speed counting in a program.

3 2 11 Scheduler switch SCHD

APB can provide clock switches for 32 time intervals at most

Line diagram/ Symbol in APB	Pin	Description
	Input ON	Set power- on time for clock switch and select the mode for it.
	Input OFF	Set power- off time for clock switch. The mode of clock switch stays at the same one as it is during power- on time.
	Output Q	The Output of the clock block. If one set time interval is ON, the output becomes 1, or it is in Status 0.

The SCHD block has a powerful clock switch function, and it has 5 switch modes for selection: Every year/ Every month/ Every week/ Every day/ Definite day

- Every year means one cycle per year;
- Every month means one cycle per month;
- Every week means one cycle per week;
- Every day means one cycle per day;
- Definite day means execute this function on this definite day without cycle;

Some key points about SCHED

1. The set time of clock switch should be according to the time order, such as Every day style

ON time: 8:00 May 01, 2002	}	Q1
OFF time: 17:00 May 01, 2002		
ON time: 9:00 Oct. 01, 2002		
OFF time: 19:00 Oct. 01, 2002		

The above time order is correct, while the following one is not correct:

ON time: 8:00 May 02, 2002	}	Q1
OFF time: 6:00 May 01, 2002		
ON Time: 19:00 Oct. 01, 2002		
OFF time: 15:00 Oct. 01, 2002		

2. In the SCHED instruction, if you set ON time and OFF time, then the output will be ON in this period from ON time to OFF time. The output will keep the previous status before the ON time, and will become OFF after the OFF time.

3. As for weekly style and every day style, you can only set ON time or OFF time. Its output will change as follow:

Set Condition	Time	Output Status
Only set ON time	Before the ON time	Keep the previous status
	At or after the ON time	ON
Only set OFF time	Before the OFF time	Keep the previous status
	At or after the OFF time	OFF

4. Whichever function you selected for the Clock switch, the time intervals of the same day should be listed according to time order. For example:

Definite day style:

8:00 May 01, 2002 ON	}	This order is correct
12:00 May 01, 2002 OFF		
13:00 May 01, 2002 ON		
17:00 May 01, 2002 OFF		

Every year style

10:00 of each June 01 ON	}	This order is wrong, and the output will become OFF from 10:00 to 11:00
11:00 of each June 01 OFF		
8:00 of each June 01 ON		
9:00 of each June 01 OFF		

Every week style:

Monday	9 00 ON	}	This order is correct
	11 00 OFF		
Monday	15 00 ON		
	18 00 OFF		

Monday	9 00 ON	}	This order is wrong, and the output will be OFF from 9:00 to 11:00
	11 00 OFF		
Monday	6 30 ON		
	8 30 OFF		

Note This phenomenon is called last instruction priority principle.

3 2 12 Time Sequence TSEQ

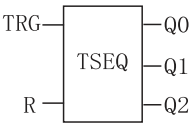
Line diagram/ Symbol in APB	Pin	Description
	Input TRG	A signal at Input TRG triggers the outputs (Output 0- 7) to be ON one by one according to the time order.
	Input R	A signal at Input R resets the outputs (Output 1- 7).
	Output Q	There are 8 outputs available, in which Output3~output7 can be selected freely, while Outputs 0- 2 are not allowed to be modified by users.

The settings for this function block are shown as follow.





Input

Trigger: I00 Output Reset: Normal

Output

Output 0: Q00 Input Output 1: Q01 Input Output 2: Q02 Input

Time settings

	h	m	s	ms	
[*]Output 0	0	0	5	0	Reference
[*]Output 1	0	0	1	0	Reference
[*]Output 2	0	0	2	0	Reference
<input type="checkbox"/> Output 3	0	0	3	0	Reference
<input type="checkbox"/> Output 4	0	0	4	0	Reference
<input type="checkbox"/> Output 5	0	0	5	0	Reference
<input type="checkbox"/> Output 6	0	0	6	0	Reference
<input type="checkbox"/> Output 7	0	0	7	0	Reference

When you select a TSEQ instruction in the program, and double click it, it will display the above figure. Then you can select the output points. If you select Output 4, output 3 will be selected automatically, and the same way for output 5, output 6, output 7. It means if you select one output, then all the previous outputs will be selected automatically. And you can set the output ON time, and the time units can be selected as milliseconds, seconds, minutes, and hours. Or you can click “ Reference” key to refer to the value of a Register (DWX).

In above figure, when the Trg becomes 1, 7 outputs will become 1 one by one. It means: Output Q0 becomes 1 when the first set time is reached, and Output Q1 becomes 1 when the second set time is reached, and so on, till the 8th set time is reached, and Output Q7 becomes 1. The output loop will start again when there is a reset signal 1 was received at Input R.

3 2 13 Step Sequence SSEQ

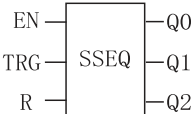
Symbol in APB	Pin	Description
	Input EN	When EN=0, output mode1 will be chosen. When EN=2, output mode0 will be chosen.
	Input TRG	8 input points in total for SSEQ block (Input0~Input 7)
	Input R	A signal at Input R resets the outputs 0~7 of SSEQ block.
	Output Q	There are 8 outputs for SSEQ block, in which output3~output7 can be selected freely, while output0~output2 are fixed, and you are not allowed to modify.

The settings for this function block are shown as follow:



→

Property[Step sequence block]

Comment

Retentivity High-speed

Input

EN	Trigger	Reset
Normal	Normal	Normal

Output

Output 0	Output 1	Output 2
Normal	Normal	Normal

Step sequence output

Output 0 Output 1 Output 2 Output 3

Output 4 Output 5 Output 6 Output 7

Feature(Double click to change)

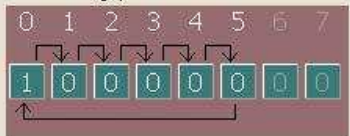

Tip: If you have chosen the output 3, output 2 must be selected, and so on.

When you select a SSEQ instruction in the program, and double click it, it will display the above figure. Then you can select the output points. If you select Output 4, output 3 will be selected automatically, the same way for output 5, output 6 output 8. It means if you select one output, then all the previous outputs will be selected automatically.

This block has two output modes, you can select it through the change between high-level and low-level signal at EN.

When EN=0, output mode 1 is selected.

Under this mode, Outputs 1-7 are triggered by a rising edge of input signal, and become ON according to the step sequence. Every time when there is a pulse trigger TRG, it will make one output become 1. And when all the selected outputs have become ON one by one, the next TRG pulse will make all the selected outputs become OFF, while Output 0 will retain the ON state, and the above cycle will start again.

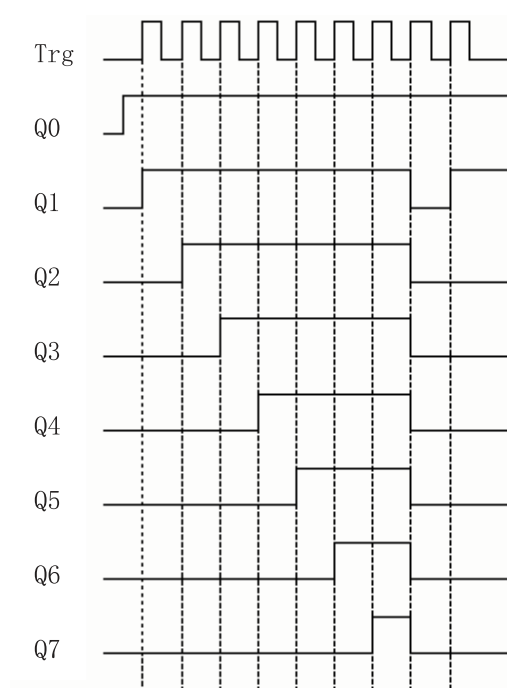

Note:

The output 0 will be in ON state all the time no matter the input TRG is ON or OFF .When EN=1, output

mode 2 is selected.

Under this mode, the output signal can be preset as 0 or 1. As it is shown in below figure, when TRG terminal is triggered first time, the preset output status is output, and each next TRG pulse will make the output status shift one bit to the right, The operation works in cycle.

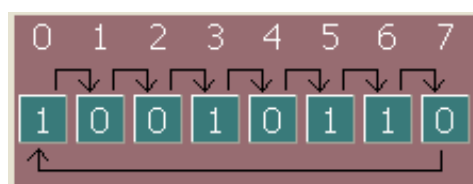

Note:

Put the mouse on 0 or 1, and double click the right key of the mouse to set 0 or 1.

3 2 14 HOUR

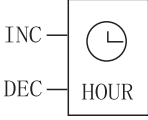
Line diagram/ Symbol in APB	Pin	Description
	Input INC	When INC was triggered by the rising edge, the internal system time will increase automatically (such as from 9:30 to 10:30).
	DEC Input	When DEC was triggered by the rising edge, the internal system time will decrease automatically (such as from 10:50 to 9:20).

Note:

1. An error occurs if the NOT gate is added at the inputs of this block.
2. This block is mainly used to automatically change APB internal system time, such as summer time, and time for different time zones etc (this block does not work for the APB main machine without RTC).

3 2 15 T/C-CMPR

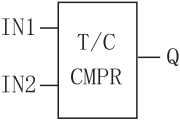
Line diagram/ Symbol in APB	Pin	Description
	Input IN1	The comparator input 1 can be connected to the output of a timer or a counter
	Input IN2	The comparator input 2 can be connected to the output of a timer or a counter
	Output Q	When the comparing requirements are met, the output Q will become 1
Comparing functions can be selected as: “<”, “>”, “<=”, “>=”, “≠”, “=”	Output P	Outputs the running value of the block to the Register D.

Functional Description:

This instruction can compare the value of timer or counter, and the compared time range is 00:00:00- 010~99:59:59- 990 (unit: hours: minutes: seconds- milliseconds). The range of counting value is 1~9999999. The type of the two connected inputs of this function block must be the same. If Input 1 is connected to the timer function block, Input 2 must be connected to the timer function block too. And if Input 1 is connected to the UDCT function block, then Input 2 must be connected to UDCT function block too.

We will explain the applications of this function block by following examples.

Example 1: Comparing the time length of two timers Logic relationship is shown as follow:

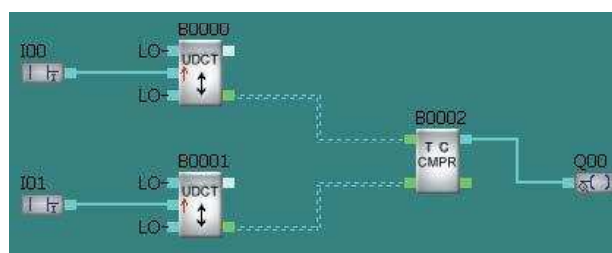

Function relationship is selected as “>” ;

Then when the time of B1 > the time of B2 QA1 is 1, otherwise, it will be 0.

Example 2: Comparing the times of two counters

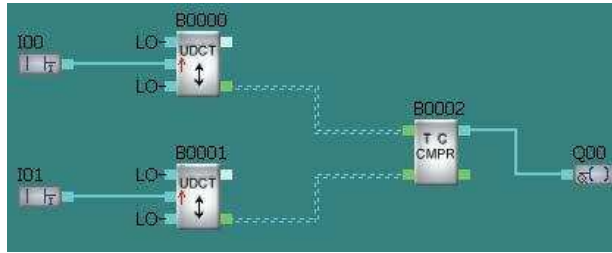

3 2 16 Stairway Lighting Switch STLT

Line diagram/ Symbol in APB	Pin	Description
	Input TRG	A 1 to 0 signal transition at input Trg (Trigger) triggers the ON-holding time T1 for the stairway lighting switch.
	Input R	A signal at input R resets the output Q.
	Output Q	A transition from 1 to 0 at input Trg (trigger) triggers the ON-holding time T1. Enables the output again after the duration of T2, and reset the output after the duration of T3.
	Output P	Outputs the running value of the block to the Register D.

Parameter Setting:

Configure the pulse width; T1 represents the OFF- delay time; T2 represents the time period when the output is off; T3 represents the ON- holding time after output is on again; Range of values: 00:00:00- 010~999:59:59 - 990(hours: minutes: seconds- milliseconds).

Time Sequence Frame

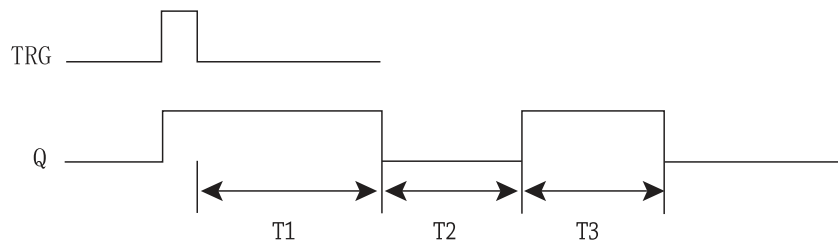

Functional Description:

A 0 to 1 signal transition at input Trg sets output Q. The next 1 to 0 transition at input Trg triggers the ON-holding time T1. Set output Q again after the expiration of T2, and it will be reset after the duration of ON-holding time T3.

3 2 17 Multiple Function Switch MULT

Line diagram/ Symbol in APB	Pin	
	Input TRG	A signal at input Trg (Trigger) sets output Q (permanent light) or resets Q with an off- delay.
	Input R	A signal at input R resets the output Q.
	Output Q	A signal at Trg enables output Q. The output Q ON time depends on the length of the input signal at Trg. The output can be switched to off- delay mode or be switched on permanently, or be reset with a reset signal at Trg.
	Output P	Outputs the running value of the block to the Register D.

Parameter Setting:

Configure the pulse width; T1 represents the off- delay time. T2 represents the time period when the high-level output is maintained. Range of values: 00:00:00- 010~999:59:59- 990(hours: minutes: seconds-milliseconds)

Time Sequence Frame

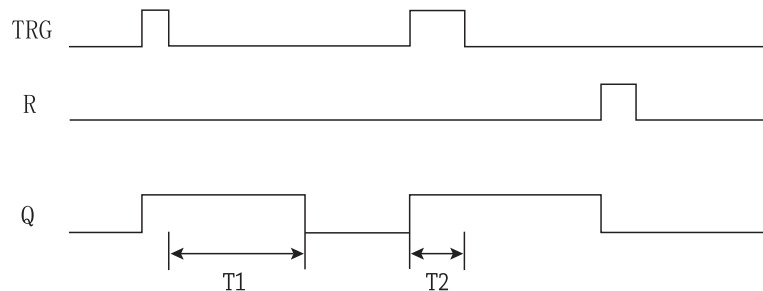

Functional Description:

If the pulse width of the signal at TRG < T2, this function block will work as Off- delay function block; if the pulse width of the signal at TRG > T2, the high- level output Q is maintained; if the reset signal R is high level, the output Q will below level.

3 2 18 SLCD Function Block SLCD

Please refer to Chapter 4 for detailed introduction about SLCD.

3 2 19 Property Pin Assignment

An output pin is defined as Property Pin in function blocks, such as timer, counter, analog function blocks etc. The output P indicates: the output P can be connected to Register D (or to Timer/Counter comparison function block). After connecting, the running values such as timer/counter/analog parameters etc. will be transmitted to Register D. When PLC is communicated with HMI, the corresponding parameters will be displayed according to the register address.

3 3 High- speed and Analog Function Blocks

Table 3: High- speed and Analog Function Blocks

Function	Line diagram	Function	Line diagram
Frequency Threshold Trigger FTH		Analog Threshold Trigger THRD	
A+ B- Counter A+B-		Analog Amplifier AMPT	
Two- phase Counter 2PCT		Analog Watchdog (AWDT)	
Pulse PTO Output PTO		Analog Threshold Trigger THRD	
PWM Output PWM		Analog Multiplexer AMUX	
Accelerate/Decelerate Single- phase Pulse Output (ACC)		Analog Math MATH	
Analog Comparator CMPR			

Analog calibration instruction:

It is necessary to have analog calibrated first to get a reference value for input analog when using the relevant analog function block. Please follow the steps given below to calibrate analog.

1. First, please power on the APB, then select “ ✖ ” item from APB LCD, and choose "Calibration" item to enter into "Calibration" screen. by pressing “ ok” and “ +” synchronously. Each channel has to be calibrated separately. Input the channel number that needs to be calibrated, and press OK key to confirm.
2. Next, When “ minimum” is prompted, input voltage value to this channel. Press OK key to confirm, then success message will be prompted, and the input value will be identified by Vmin. When “ maximum” is prompted, input maximum voltage value to this channel. Press OK key to confirm, then success message will be prompted, and the input value will be identified by Vmax. The input range for Vmin and Vmax is between 0V to 10V.
3. After the analog has been calibrated successfully APB need to be cut off the power supply and then it is power on.
4. It's same for other channels. If the analog has been calibrated successfully, when using relevant analog function blocks, the analog input value (0V- 10V) is not the actual input voltage value, but the calculation result of the math formula: $(V_{input} - V_{min}) / (V_{max} - V_{min}) * 10$.

3 3 1 Frequency Threshold Trigger FTH

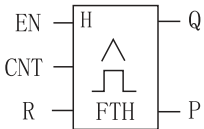
Line diagram/ Symbol in APB	Pin	Description
	Input EN	A positive edge at input EN triggers frequency threshold trigger. A negative edge at input EN triggers frequency threshold trigger.
	Input CNT	Optional counter mode 1. Rising edge counter When rising edge counter mode is chosen The counter just counts the change from status 0 to status 1 and doesn't count the change from status 1 to status 0 2. Descending edge counter When descending edge counter mode is chosen The counter just counts the change from status 1 to status 0 and doesn't count the change from status 0 to status 1
	Input R	A signal at input R resets the internal count value to zero, and the output (R takes priority over CNT).
	Output Q	Q is set or reset, depending on the set thresholds.
	Output P	Outputs the running value of the block to the Register D.

Parameter Setting

on On threshold; Range of values: 0000...99999999

off Off threshold; Range of values: 0000...99999999

Time parameter T: Time interval or gate time when the input pulses are measured; range of values: 00:00:00-010~999:59:59- 990 (hours: minutes: seconds- milliseconds).

Time Sequence Frame

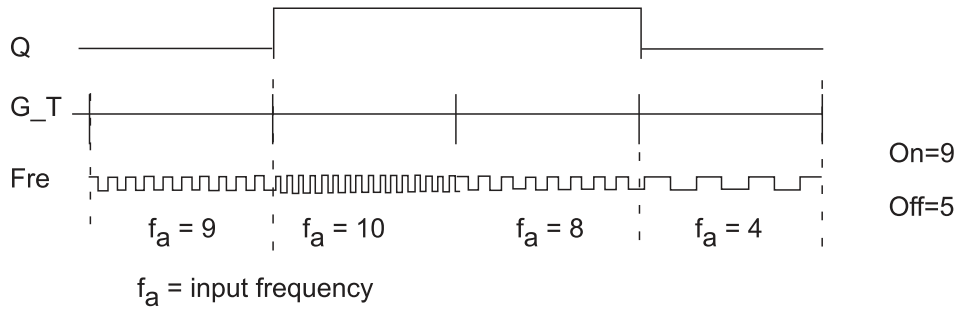

Functional Description

If the On threshold \geq Off threshold, then:

$Q=1$, if $f_a \geq \text{On}$

$Q=0$, if $f_a < \text{Off}$

If the On threshold $<$ Off threshold, then:

$Q=1$, if $n \leq f_a < \text{Off}$

Notes

1. The counting frequency is related to filtering duration. If the default filtering duration is 50ms, please choose high-speed running mode when input frequency exceeds 4HZ.
2. I4~I7 are high-speed inputs. Each high-speed input only can be connected with a function block of high-speed counting in a program.

3 3 2 A+B- Counter (A+B-)

Line diagram/ Symbol in APB	Pin	Description
	Input R	A signal at input R resets the internal count value to zero, and the output (R takes priority over CW and CWW).
	Input	The counter is counting up when there is a signal at input CW (counter). The counter is counting down when there is a signal at input CWW (counter). The function counts the 0 to 1 transitions at input, while 1 to 0 transitions are not counted.
	Output Q	When count value is reached, the Output Q is enabled.
	Output P	Outputs the running value of the block to the Register D.

Parameter Setting

Range of values: 0- 99999999

Time Sequence Frame:

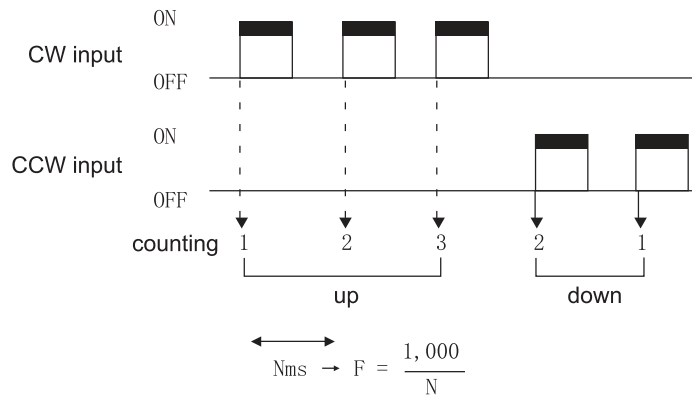

Functional Description:

1. The counter is counting up when there is a signal at input CW (counter).
2. The counter is counting down when there is a signal at input CWW (counter).
3. Retentivity function and high- speed running function are optional.

Notes

1. The counting frequency is related to filtering duration. If the default filtering duration is 50ms, please choose high- speed running mode when input frequency exceeds 4HZ.
2. I4~I7 are high- speed inputs. Each high- speed input only can be connected with a function block of high- speed counting in a program.

3 3 3 Two- phase Counter 2PCT

Line diagram/ Symbol in APB	Pin	Description
	Input R	A signal at input R resets the internal count value to zero, and the output (R takes priority over A and B).
	A/B phase input	Input signal for two differential phases (A phase and B phase) increases or decreases by multiplication factors 1, 2 and 4.
	Q Output	When count value is reached, the Output Q is enabled.
	Output P	Outputs the running value of the block to the Register D.

Time Sequence Frame:

1 Multiplication factor 1:



2 Multiplication factor 2:

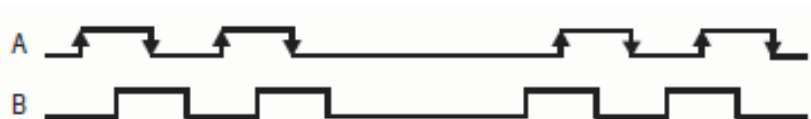

3 Multiplication factor 4:

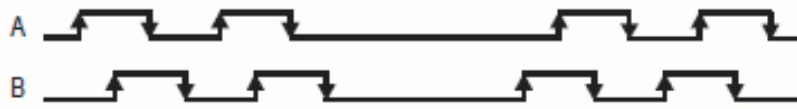

Functional Description:

In the differential- phase input mode, the count value increases or decreases by multiplication factors 1, 2 and 4 of the two differential phases signal.

- 2. Retentivity function is optional;
- 3. High- speed running function must be selected.

Notes 1. Differential signals have to be input from I4, I5 port of PLC;

- 2. I4~I7 are high- speed inputs. Each high- speed input only can be connected with a function block of high- speed counting in a program.

3 3 4 Pulse Output PTO

Symbol in APB	Pin	Description
	Input TRG	A signal at input Trg (Trigger) triggers the pulse output PTO.
	Input R	A signal at input R resets the pulse output.
	Output Q	A series of square waves are output according to the preset pulse cycle and the number of the pulse.
	Output P	Outputs the running value of the block to the Register D.

Parameter Setting

Pulse number Range of values: 0~99999999

Frequency Range of values: 1~100000

Time Sequence Frame:

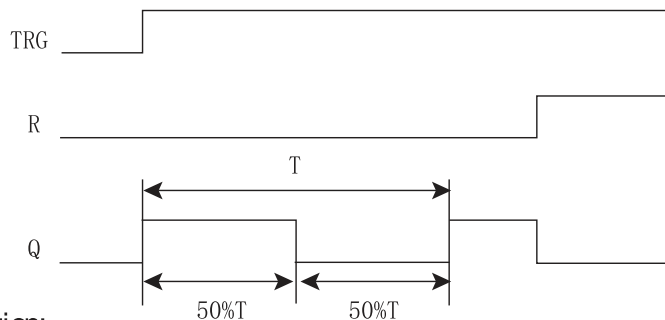

Functional Description:

- 1. A series of square waves are output according to the preset pulse cycle and the number of the pulse. The duty cycle is fixed at 50%.
- 2. It is allowed to set pulse number and frequency value under the independent mode, while the pulse number is unable to be set under the continuous mode, and the square waves will be output continuously at a certain frequency.
- 3. High- speed running function must be selected.
(If the number of the pulse is 0, it will be run under the continuous mode).

Note: PTO pulse output only can be connected to output Q2 or Q3.

3 3 5 PWM Output PWM

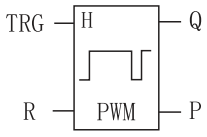
Symbol in APB	Pin	Description
	Input TRG	A signal at input Trg (Trigger) triggers the PWM pulse output.
	Input R	A signal at input R resets the pulse output.
	Q Output	A series of square waves are output according to the preset duty cycle, pulse cycle and the number of the pulse.
	Output P	Output the running value of the block to the Register DW.

Parameter Setting

Pulse number Range of values: 0~99999999

Frequency Range of values: 1~100000

Duty cycle Range of values: 10~100

Time Sequence Frame:

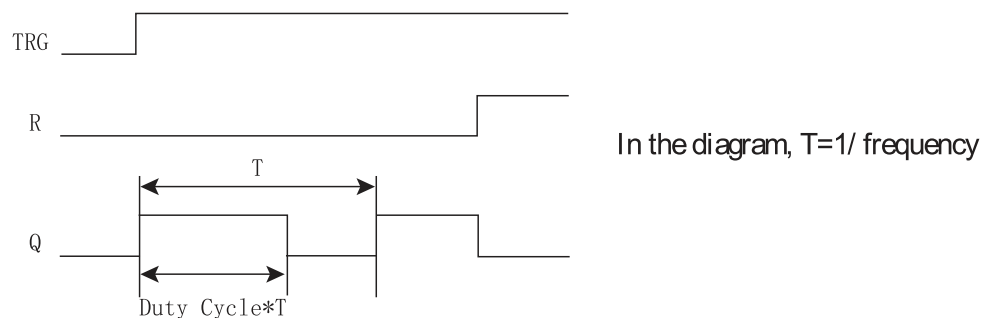

Functional Description:

1. A series of square waves are output according to the preset number of the pulse, frequency, and duty cycle.
2. It is allowed to set pulse number, frequency value, and duty cycle under the independent mode, while the pulse number is unable to be set under the continuous mode, and the square waves will be output continuously at a certain frequency.
3. High-speed running function must be selected.

Note: PWM output only can be connected to output Q2 or Q3.

3 3 6 Accelerate/Decelerate Single-phase Pulse Output (ACC)

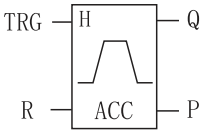
Symbol in APB	Pin	Description
	Input TRG	A signal at input Trg (Trigger) triggers ACC pulse output.
	Input R	A signal at input R (Reset) resets the pulse output.
	Output Q	Output pulse command specifying frequency and pulse number.
	Output P	Output the running value of the block to the Register DW.

Parameter Setting:

Start frequency (SF)	Range of values: 1- 100000
End frequency (EF)	Range of values: 1- 100000
Accelerating (Decelerating) time (t)	Range of values: 10- 5000ms
Number of segments (n)	Range of values: 1- 100
Number of output pulse:	Range of values: 1- 99999999

Time of each segment $\Delta t = t / \text{segments } n$

Frequency of each segment $\Delta f = \text{Start frequency} - \text{End frequency} / n - 1$

Pulse number of each segment $= \Delta t / 1/f$

Condition 1 Start frequency \leq End frequency

Condition 2 $\Delta t \geq 1/\text{Start frequency}$

Time Sequence Frame:

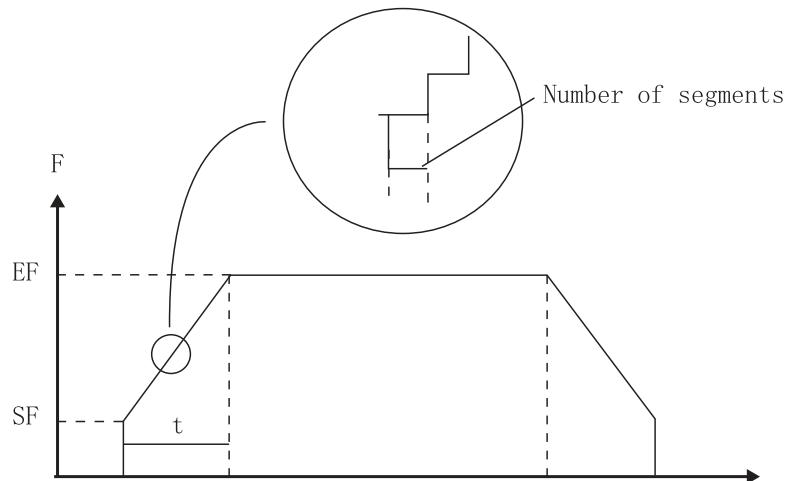

Functional Description:

1. Output pulse with acceleration and deceleration depending on assigned parameters
2. High-speed running function must be selected.

3 3 7 CMPR

Symbol in APB	Pin	Description
	Input AIX	Analog Input AIX can be selected as: the preset analog value or the calculated from the analog input IA.
	Input AIY	Analog Input AIY can be selected as: the preset analog value or the calculated value from the analog input IA.
	Output Q	When the conditions are satisfied, the output Q will be 1.
Comparing function, can be selected as: “ < ”, “ > ”, “ <= ”, “ >= ”, “ ≠ ” “ = ”	Output P	Output the running value of the block to the Register DW.

Parameter Setting:

A Gain value; Range of values: - 10000~10000

B Offset value; Range of values: - 20000~20000

Functional Description:

Only APB- 12MRD, APB- 12MTD, APB- 12MGD, APB- 22MRD, APB- 22MTD, APB- 22MGD types have this function.

CMPR Description:

The CMPR compared value of the analog input (IA) is valued out through math formula, and it is not the actual input voltage value. The math formula is $(V_{input} - V_{min}) / (V_{max} - V_{min}) * 10$. Please see the Analog calibration for details.

CMPR will compare the calculated value of the input AIX and input AIY. When the comparison function is selected as “ < ” , it means the calculated value of input AIX is smaller than that of input AIY, and the output is high, otherwise, the output will be low.

It is allowed to set one value of input AIX or input AIY as the fixed value, and the other is connected to the analog input. Thus CMPR will compare this fixed value and the calculated value of the analog input.

Example 1: Comparing the calculated value of input AIX and input AIY.

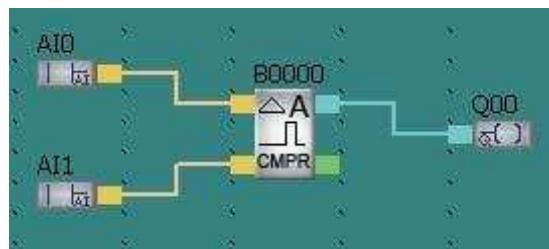

Input 2 is connected to AI1;

Output is connected to QA0;

CMPR function is selected as “ <= ” ;

Then: if the calculated value of AI0 is <= the value of AI1, Q00 will become 1, otherwise, Q00 will become 0.

Example 2: Comparing the calculated value of the analog input 1 with the fixed value.

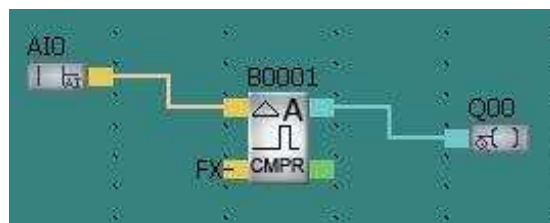

Input 1 is connected to AI0;

Input 2 is empty. Then select the Input 2 from the property dialogue frame and input proper fixed value;

Output is connected to QA0;

CMPR function is selected as “ <= ” .

Then: if the calculated value of AI0 is <= the fixed value, QA0 will become 1, otherwise, QA0 will become 0.

3 3 8 Analog Threshold Trigger THRD

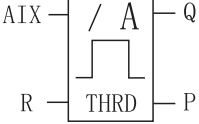
Symbol in APB	Pin	Description
	Reset R	A signal at input R resets the analog threshold trigger.
	Input AIX	Analog input can be selected as a calculated value from the analog input IA, or the preset analog value.
	Output Q	When the conditions are satisfied, the output Q will be 1.
	Output P	Output the running value of the block to the Register DW.

Parameter Setting:

A Gain value; Range of values: - 10000~10000

B Offset value; Range of values: - 20000~20000

On On threshold; Range of values: - 20000~20000

Off Off threshold; Range of values: - 20000~20000

Time sequence frame:

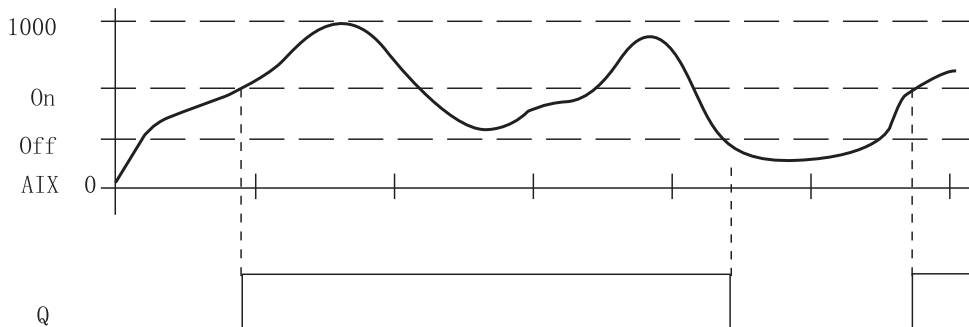

Functional Description:

The function fetches the analog signal at input AIX.

AIX is multiplied by the value of the A (gain) parameter, and the value at parameter B (offset) is added to product, i.e. $(AIX * gain) + offset = \text{actual value of AIX}$.

If the On threshold \geq Off threshold, then:

Q=1, if the actual value $AIX > On$

Q=0, if the actual value $AIX \leq Off$.

If the On threshold < Off threshold, then:

Q=1, if $On \leq \text{actual value AIX} < Off$.

3 3 9 Analog Amplifier AMPT

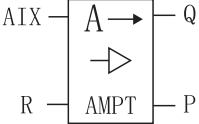
Symbol in APB	Pin	Description
	Reset R	A signal at input R resets the analog amplifier.
	Input AIX	Analog input.
	Output Q	Input value is output after calculation.
	Output P	Output the running value of the block to the Register DW.

Parameter Setting:

A Gain value; Range of values: - 10000~10000

B Offset value; Range of values: - 20000~20000

Functional Description:

The input value is multiplied by the value of the A (gain) parameter, and then parameter B (offset) is added to the product: $(Ax * gain) + offset = actual\ value\ AIx$.

The actual value AIX is output at Q.

3 3 10 Analog Watchdog AWDT

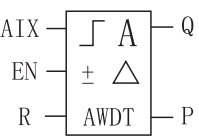
Symbol in APB	Pin	Description
	Input AIX	Analog input.
	Input EN	A positive edge (0 to 1 transition) at input En saves the analog value (V) at input AIX to memory and starts monitoring the range of analog values.
	Reset R	A signal at input R resets the analog watchdog.
	Output Q	Q is set or reset, depending on the stored analog value and the offset.
	Output P	Output the running value of the block to the Register DW.

Parameter Setting:

A: Gain value; Range of values: - 10000~10000

B: Offset value; Range of values: - 20000~20000

1: Difference value above V; range of values: 0.00~20000.00

2: Difference value below V; range of values: 0.00~20000.00

Time sequence frame:

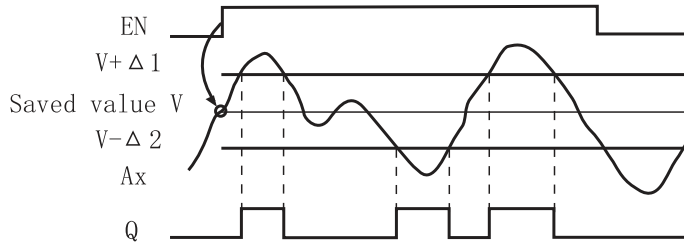

Functional Description:

A positive edge (0 to 1 transition) at input En saves the analog value (V) of input AIX to memory. If analog value > V+ 1 or < V- 2, a high-level signal is output at Output Q.

3 3 11 Analog Differential Trigger (WARP)

Symbol in APB	Pin	Description
	Input AIX	Analog input.
	Reset R	A signal at input R resets the analog differential amplifier.
	Output Q	Q is set or reset, depending on the threshold and the offset.
	Output P	Output the running value of the block to the Register DW.

Parameter Setting:

- A Gain value; Range of values: - 10000~10000
- B Offset value; Range of values: - 20000~20000
- ON: On threshold; range of values: - 20000.00~20000.00
- Offset value; Range of values: - 20000.00~20000.00

When the positive difference is set, if $On \leq \text{actual value Aix} < On + 1$, then $Q=1$. The time sequence frame is shown as below:

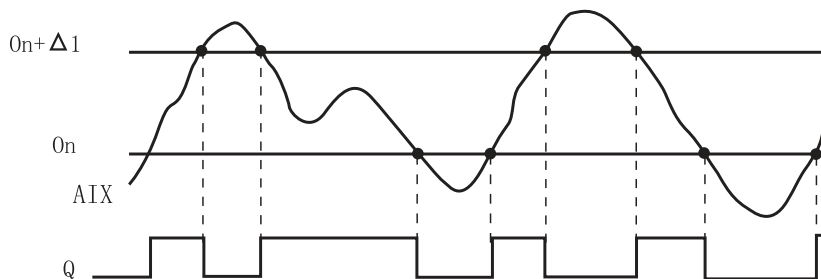

When the negative difference is set

- If actual value Aix > On, then $Q=1$;
- If actual value Aix $\leq On + 2$, then $Q=0$.

Time sequence frame:

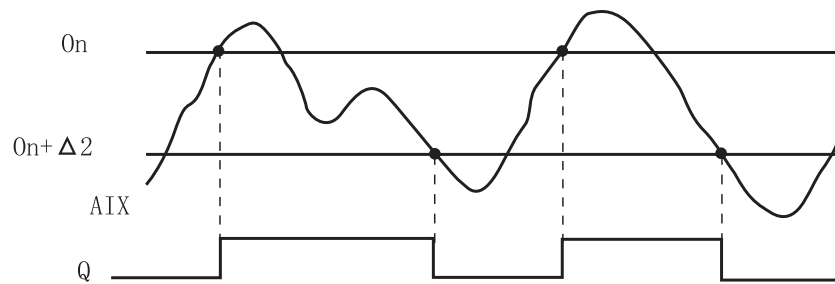

Functional Description:

Q is set or reset, depending on the threshold (ON) and the offset ().

3 3 12 Analog Multiplexer AMUX

Symbol in APB	Pin	Description
	Input EN	A transition from 0 to 1 at input En (Enable) outputs a parameterized analog value, depending on the value of S1 and S2.
	Input S1, S2	S1 and S2 (selectors) are used to select the analog value that needs to be output. <ul style="list-style-type: none"> · S1=0 and S2=0: output value: V1 · S1=0 and S2=1: output value: V2 · S1=1 and S2=0: output value: V3 · S1=1 and S2=1: output value: V4
	Output Q	Output an analog value.
	Output P	Output the running value of the block to Register DW.

Parameter Setting:

V1 value range: - 20000.00 - 20000.00

V2 value range: - 20000.00 - 20000.00

V3 value range: - 20000.00 - 20000.00

V4 value range: - 20000.00 - 20000.00

Time sequence frame:

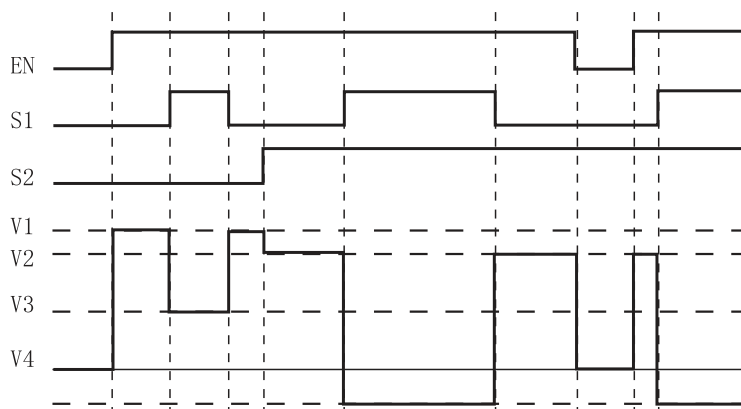

Functional Description:

If input En is set, this function will output one of 4 possible analog values V1 to V4, depending on the value of S1 and S2.

If S1=0 and S2=0, output the value of V1;

If S1=0 and S2=1, output the value of V2

If S1=1 and S2=0, output the value of V3

If S1=1 and S2=1, output the value of V4

3 3 13 Analog Math MATH

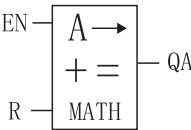
Symbol in APB	Pin	Description
	Input En	A transition from 0 to 1 at input En (Enable) enables the analog math function block.
	Input R	A signal at input R resets the analog calculator.
	Output Q	The output QA is the result of the equation formed from the operand values and operators. An error will occur if QA is divided by 0 or the result exceeds 99999999.
	Output P	Output the running value of the block to Register DW.

Parameter Setting

V1: First operand value

V2: Second operand value

V3: Third operand value

V4: Fourth operand value

Op1: First operator

Op2: Second operator

Op3: Third operator

Pr1: Priority of first operation

Pr2 Priority of second operation

Pr3 Priority of third operation

Functional Description:

The analog math function combines the four operands and three operators to form an equation. The operator can be any one of the four standard operators: +, -, *, or /. It is necessary to set a unique priority of High (H), Medium (M), or Low (L) for each operator. The High (H) operation will be performed first, followed by the Medium (M) operation, and at last the Low (L) operation will be performed. One operation has to correspond with one priority. For the operand values, you can refer to other relevant predefined function.

The number of operand values is fixed at 4 and the number of operators is fixed at 3. If you need to use fewer operands, please use constructions such as + 0 or * 1 to fill the remaining parameters.

You are allowed to configure the behavior of the function when the Enable parameter En=0. The function block can either keep its last value, or be set to 0.

3 4 APB Input & Output Blocks : Six in total

Table 4: I/O Blocks

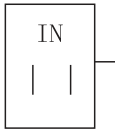
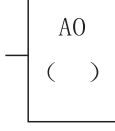
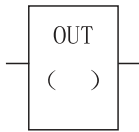
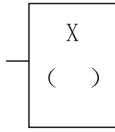
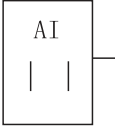
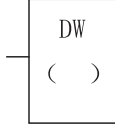
Function	Line diagram	Function	Line diagram
Digital input IN		Analog Output AO	
Digital output OUT		Blank Output X	
Analog Input AI		Register D D	

Input

1. Digital Input (DI)

Digital input is identified by I, M, Q. These identifiers correspond to those used for PLC input, output and intermediate relays in program.

2. Analog Input AI

Analog input is identified by AI, AM, AQ. The DC type PLC input can be programmed as AI input.

Output

1. Digital Output

Digital output is identified by M, Q. These identifiers correspond to those used for PLC output and intermediate relays in program.

2. Analog Output

Analog output is identified by AO

3. Blank Output

Connect to the output that is not used.

Register D

The timer, counter, and analog values can be output to Register D with property pin, and in the meantime, the function blocks use the value of Register D as the set parameter for timer, counter and analog.

Note: 1. An error may occur when Register D is used without a value for it.

2. If the function block uses the value of Register D, this value is unable to be modified on the Parameter Setting interface of APB- LCD.



Chapter IV Instructions of APB- SLCD

APB- SLCD is used to display time, I/O status, and values of counter, timer, and analog etc. The display interface can be self- defined. HMI only can be used to display information data, and modify the parameters, but it can not be used for programming.

4 1 Introduction of SLCD SLCD





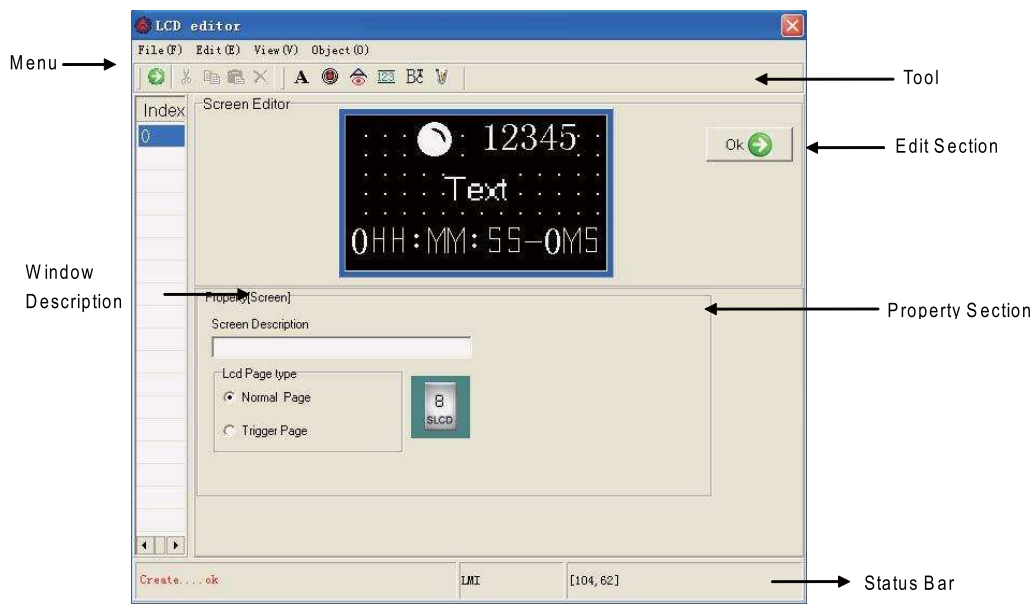

The display content of APB- HMI can be self- defined with this function block. It is able to monitor, set, and modify I/O status, as well as the value of PLC internal register with characters, indicator, register and parameters, which makes the real- time monitoring of PLC running status for the operator very convenient. And you can connect the alarm signal to the trigger input of SLCD to display the alarm message. At most 64 human- machine interfaces can be edited.















4 1 1 Introduction of Operation Interface

Add the function block  to the edit window, and the following operation interface will be popped up after double clicking .



Tool Bar	
	Exit LCD editor
	Cut components
	Copy components
	Paste components

	Delete components
	Static text: including Chinese characters, English characters and other character system
	Indicator: displaying input/output of PLC and the on/off status of internal relays
	Message display: displaying the corresponding message when the ON/OFF of PLC components.
	Register: placing the data- monitoring or data- setting components (the operated object is the data register in PLC)
	Function block parameters: displaying the function block parameters in program
	Graphics file (the Max. size: 108* 64 pixels)

Distribution Bar	
	Place on the above layer
	Place on the next layer
	Left align all selected objects
	Right align all selected objects
	Top align all selected objects
	Bottom align all selected objects
	Align the left edge of all selected objects
	Align the right edge of all selected objects
	Align the top edge of all selected objects
	Align the bottom edge of all selected objects
	Align in the middle of all selected objects horizontally
	Align in the middle of all selected objects vertically
	Align all selected objects with equal horizontal space
	Align all selected objects with equal vertical space

File

Click “ File” menu, and choose “ Exit” to exit LCD editor.

Edit

This instruction is mainly used for tool management, including Cut, Copy Paste, Delete, Select all, Control, Position and so on. The pull- down menu is shown as the follow:

Menu Name	Function
Cut	Cut components
Copy	Copy components
Paste	Paste components
Delete	Delete components
Select all	Select all components
Control	Change the arrangement
Position	Set alignment type
Save Screen Bitmap	Save the current screen as graph format
Show back dot(G)	Display

View

This menu includes the Toolbar, distribution bar and Status bar. The pull- down menu is shown as follow:

- ▲ Tool bar: Toolbar displaying instruction
- ▲ Distribution bar: Distribution bar displaying instruction
- ▲ Status bar: Status bar displaying instruction

Object

This menu mainly includes Static text, Lamp, Message display, Function block parameter and Picture.

Menu Name	Function
Static text	including Chinese characters, English characters and other character system
Lamp	displaying input/output of PLC and the on/off status of internal relays
Message display	Message display, the corresponding message will be displayed when PLC objects become ON/OFF
Register	placing the data- monitoring or data- setting components (the operated object is the data register in PLC)
Function block parameter	Displaying the function block parameters in program, or the running value of function block.
Picture	Graphics file (the Max. size: 108* 64 pixels)

4 1 2 Operation Interface Edit

Static Text

Choose “ Static Text” option in the “ Object” menu or click the icon  in the tool bar. And then a dashed rectangular frame following the mouse appears. Move the mouse to the proper position of the edit section and click the left button of the mouse to confirm.

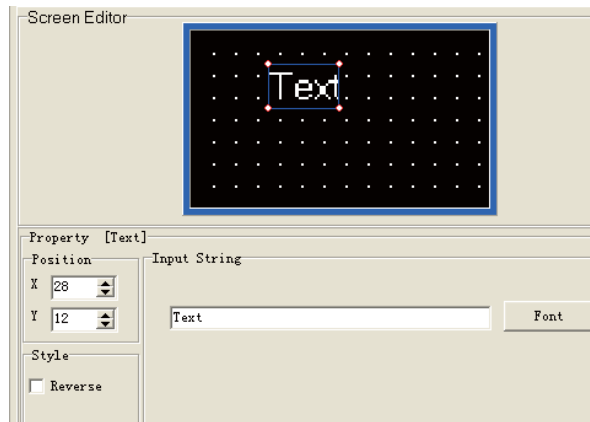

▲ Position Property

X Position: specifying the horizontal position of the component

Y Position: specifying the vertical position of the component

Note: The grid origin is on the top left corner of the screen

▲ Input String

Input relevant text to explain, the font of which can be modified through clicking Font.

▲ Style

Reverse: the static text box and the background color will be reversely displayed.

▲ Font

Set the font of the text.

Note: Position and Reverse is common property, which is shared by other controls.

Lamp

Choose “ Lamp” option in “ Object” menu or click the icon  in the tool bar. And then a dashed rectangular frame following the mouse appears. Move the mouse to the proper position of the edit section and click the left button of the mouse to confirm.

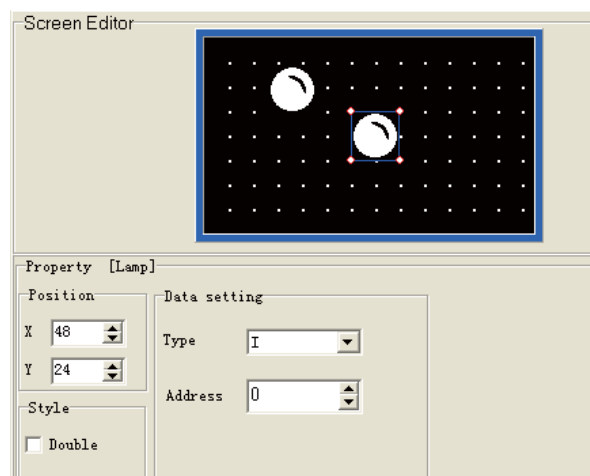

▲ Coil Property

The type and address correspond to the input/output points of PLC and the type/address of internal relay.

▲ Style

Double: The displaying picture of the lamp will be doubled correspondingly.

If the corresponding internal relay is ON, the lamp will be solid; and if the corresponding internal relay is OFF, the lamp will be hollow.

Note: Double is common property. It is shared by other controls.

Message Display

Choose “ Message Display” option in “ Object” menu or click the icon in the tool bar. And then a dashed rectangular frame following the mouse appears. Move the mouse to the proper position of the edit section and click the left button of the mouse to confirm.

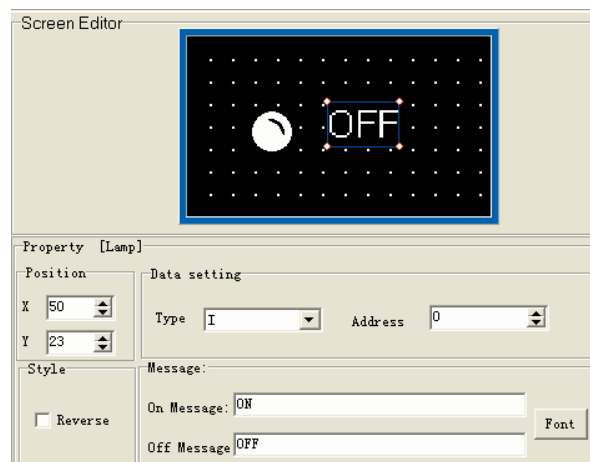

▲ Coil Property

The type and address correspond to the input/output points of PLC and the type/address of internal relay.

▲ Message Display

Display the corresponding message when the coil is ON/OFF.

Register

Choose “ Register” option in “ Object” menu or click the icon  in the tool bar. And then a dashed rectangular frame following the mouse appears. Move the mouse to the proper position of the edit section and click the left button of the mouse to confirm.

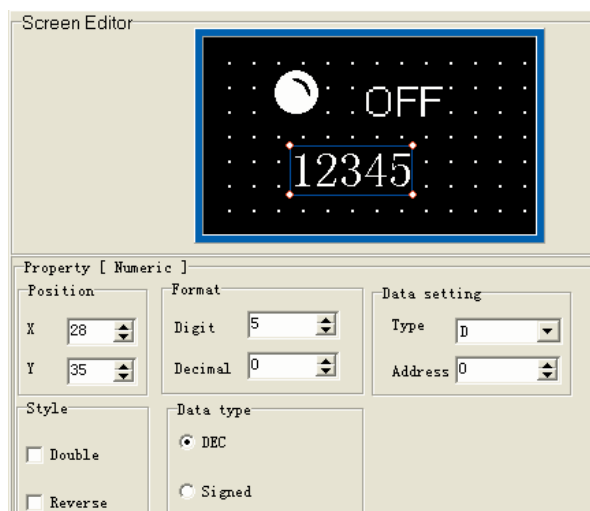

▲ Format

Set the digits and decimal digits of the register data.

If it displays analog voltage value, please set two decimal digits.

▲ Register

Set the type and address of PLC register

If the "Set" check box is selected, the "Password" option will be displayed. When the "Password" option is selected, if user wants to set value through " + - " keys on PLC front panel, it is necessary to press ENTER key to enter into the password interface and then input the correct password.

Block Info

Choose " Block Info" option in " Object" menu or click the icon  in the tool bar. And then a dashed rectangular frame following the mouse appears. Move the mouse to the proper position of the edit section and click the left button of the mouse to confirm.

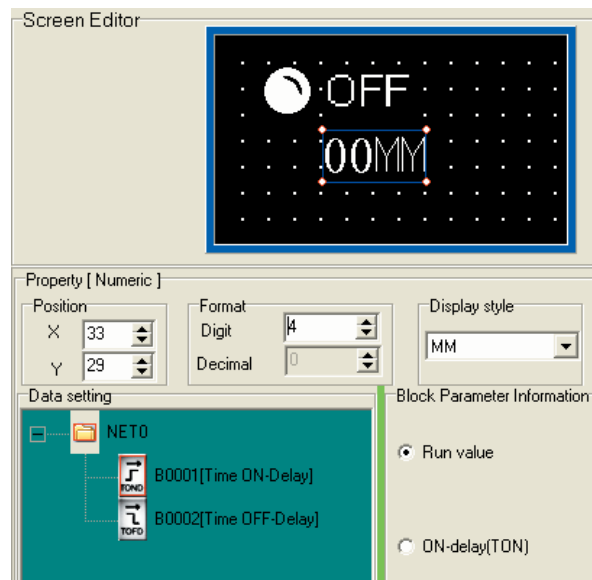

▲ Format

Set the displayed digits and decimal digits of the parameter.

▲ Display Type

Several selectable types are shown as follows:

HH MM SS- MS Hours: Minutes: Seconds- Milliseconds

HH MM SS Hours: Minutes: Seconds

HH MM Hours: Minutes

MM SS Minutes: Seconds

MM Minutes

SS Seconds

MS Milliseconds

▲ Function Block Parameter

The set parameter or the running value of the function block can be set to display according to the actual needs.

Triggered page

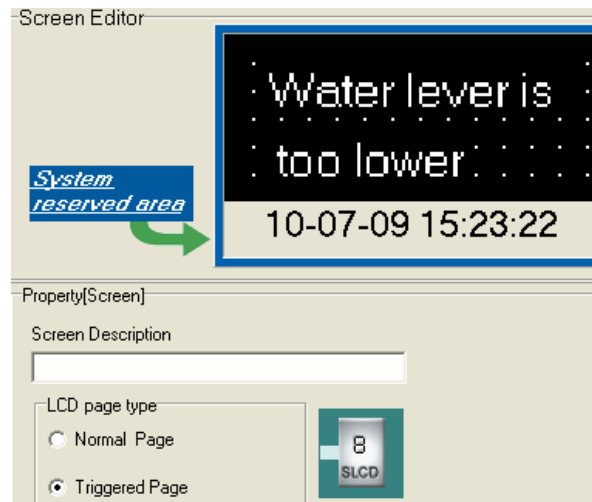

▲ LCD page type

Choose Triggered Screen

When the alarm is triggered, the time when alarm message prompted will be displayed on “ System reserved area” section, and this section is disabled when the alarm interface is editing.

Initial screen NO.

If cross the “ Initial screen NO.” any user- defined screen will be set as initial screen

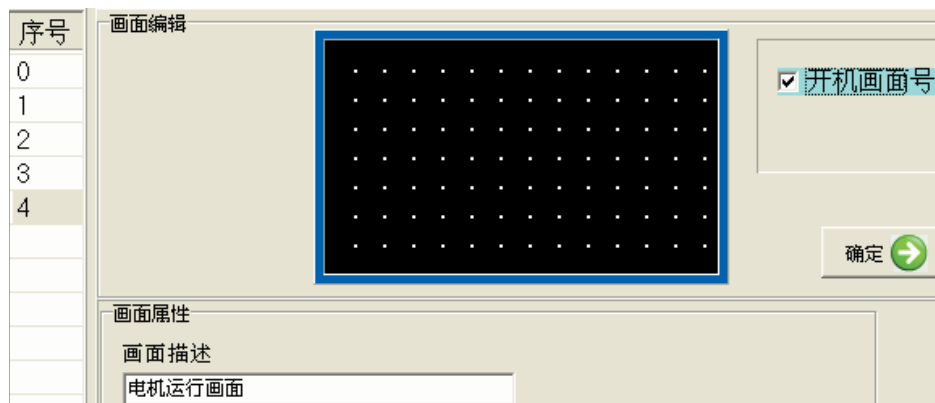

4 1 3 APB- HMI Application Examples

Note: This is an example for a water supply system.

1. The water supply system diagram is shown as follow:

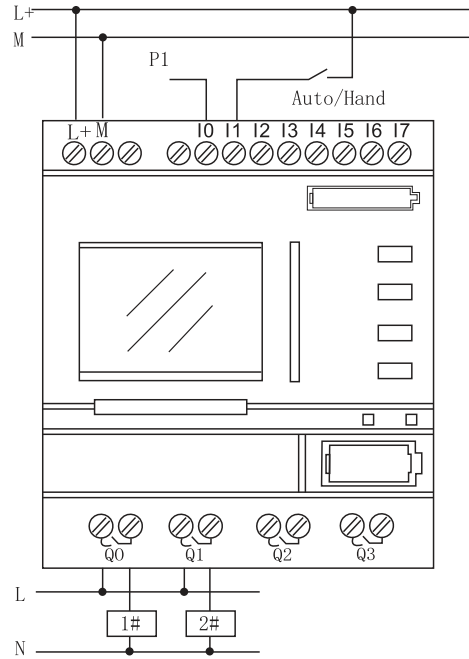
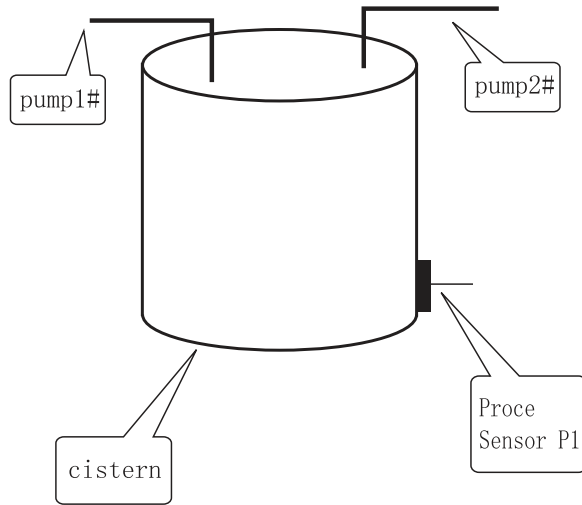

2. Description:

- a. We use an APB- 12MRD to compare pressure sensor P1 with 7V, if $P1 < 7v$, then start the pump #1 (QA0); if $P1 < 3v$, then start the pump #2 (QA1); P1 is input from IA0.
- b. SA is a Manual/Auto switch which is connected to IA1.
- c. When SA is selected as manual switch, IA3 controls pump #1, and IA4 controls pump #2.
- d. When SA is selected as Auto switch, the analog comparators B0, B1, and B6 are defined in APB-12MRDC. The parameters are set as follows:

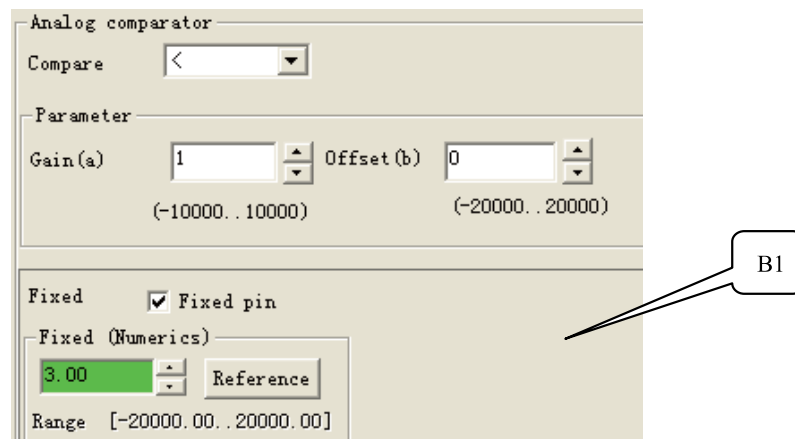
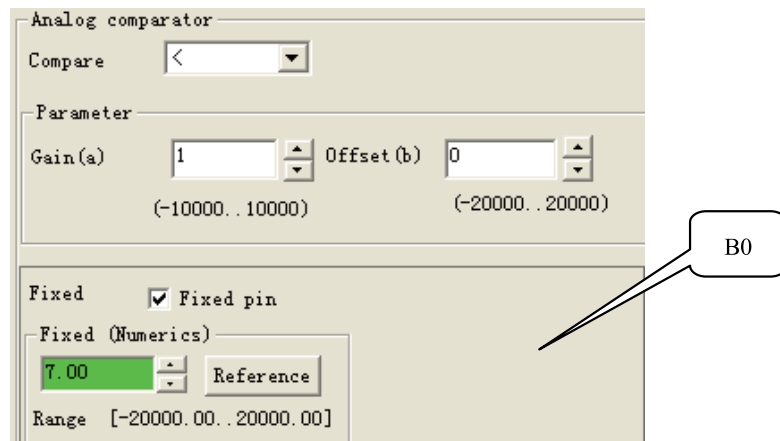

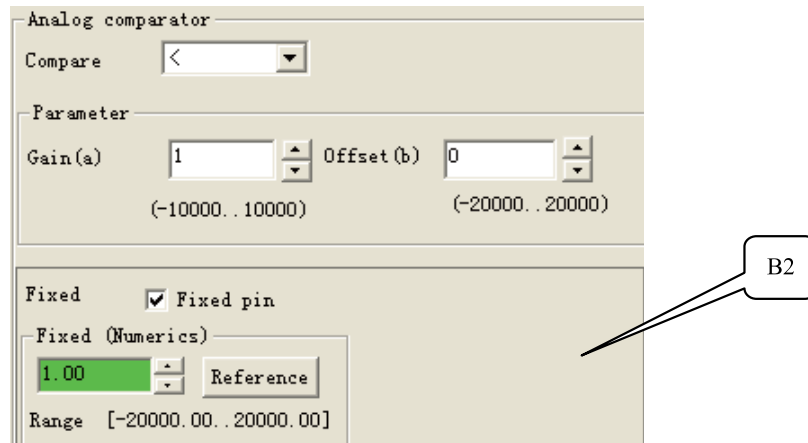

B0 will control the pump #1; B1 will control the pump #2; B2 will control the alarm

The logic control program of APB- 12MRDC is shown as follow:

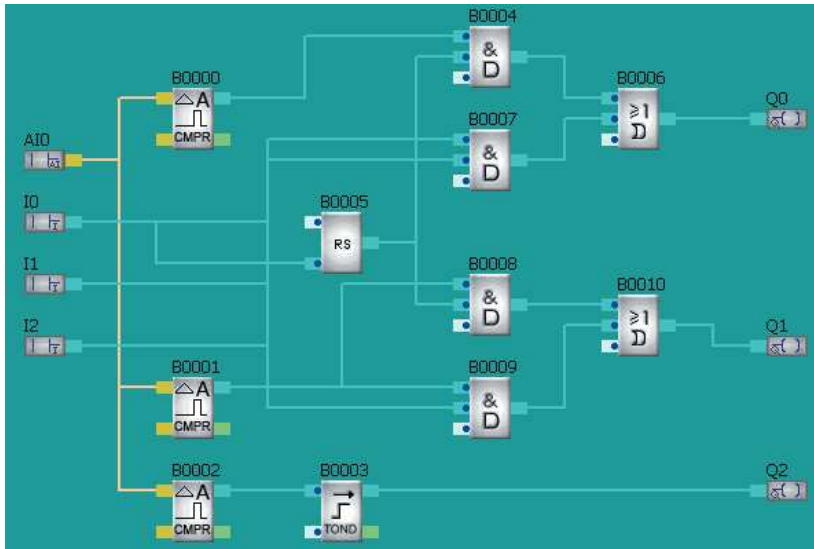

In this case, the following messages need to be displayed on the APB- HMI :

1. The running value of the pressure sensor P1 and the set value of the analog comparator;
2. If $P1 < 1V$, the alarm message will be displayed;
3. The set value and running value of the time delay relay;

Operation procedures:

1. Set a function block  in the program.

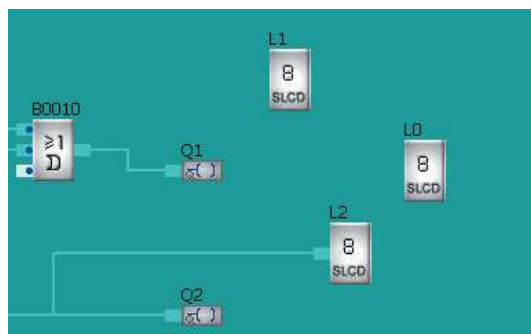

The function block L0 displays the set value and the running value of time delay relay.

The function block L1 displays the running value of the pressure sensor P1 and the set value of the analog comparator.

The function block L2 displays the alarm message, if $P1 < 1V$.

2. Create a screen page for “ Set value and current value of time delay relay”

Choose component “ A” to input text message “ current value of time delay relay”

Choose component “ A” to input text message “ Set value of time delay relay”

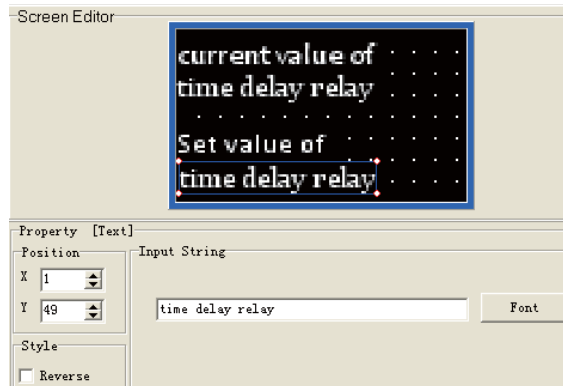

Choose the component “ **BE** ” , and select “ Function block B0003 (ON- delay).The “ current value” is chosen as the parameter. Displayed digits: 2; decimal digits: 0

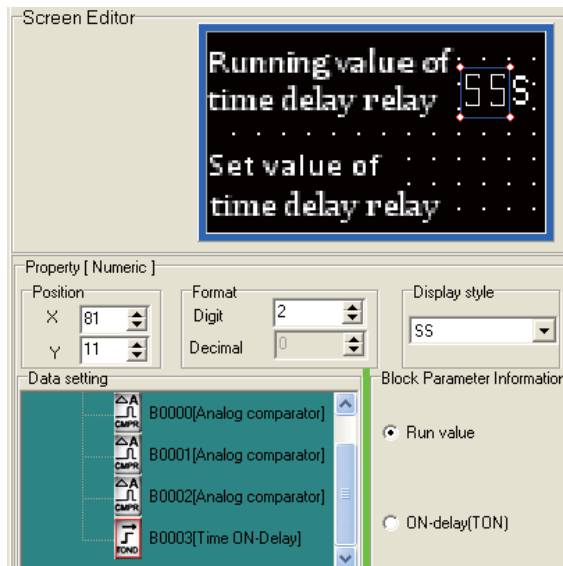

Choose the component “ **BE** ” , and select “ Function block B0003 (on- delay).The “ ON- delay” is chosen as the parameter. Displayed digits: 2; decimal digits: 0.

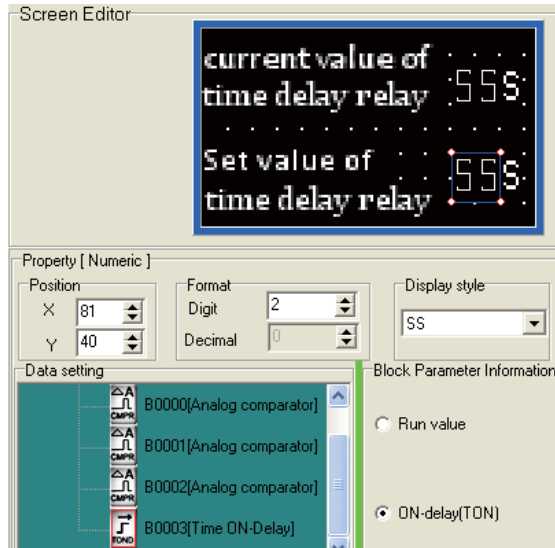

3. Create a screen page for “ Display the current value of pressure sensor P1 and the set value of analog comparator” .

- Choose component “ A ” to input text message “ Pressure sensor”
- Choose component “ A ” to input text message “ Value”
- Choose component “ A ” to input text message “ Analog comparator”
- Choose component “ A ” to input text message “ Fixed value”

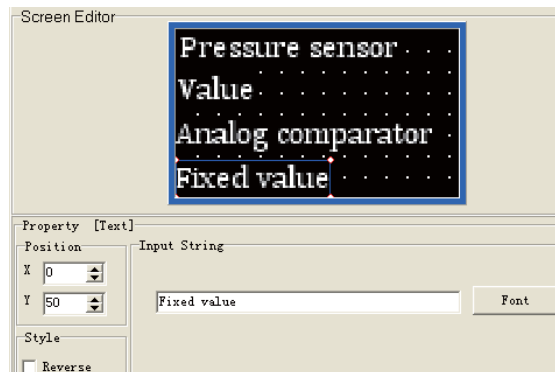

Choose the component “ **BA** ” , and select “ Function block B0000 (universal analog comparator).The “ Running value of the block” is chosen as the parameter. Displayed digits: 3; decimal digits: 2.

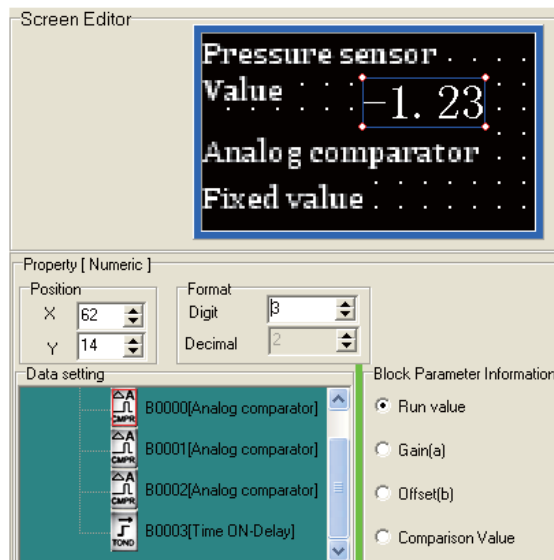

Choose the component “  ” , and select “ Function block B0000 (universal analog comparator).The “ Running value of the block” is chosen as the parameter. Displayed digits: 3; decimal digits: 2.

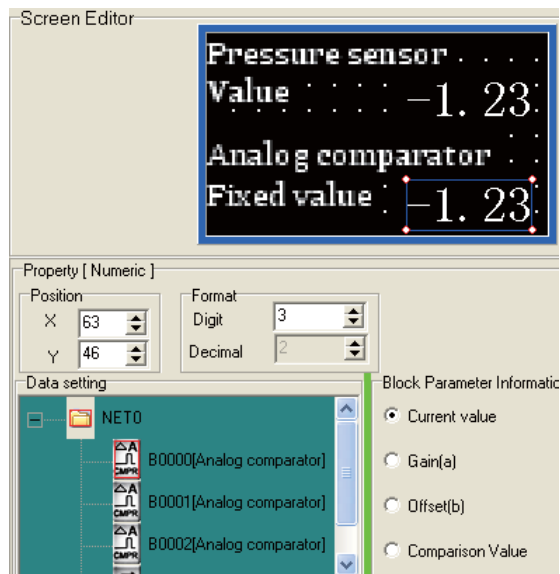

4. Create the alarm message screen for $P1 < 1V$ situation

If it is necessary to create a screen for alarm message, “ Triggered Screen” has to be selected from the “ LCD page type” , then input the displayed message, such as: “ The water level is too low in water tank” .

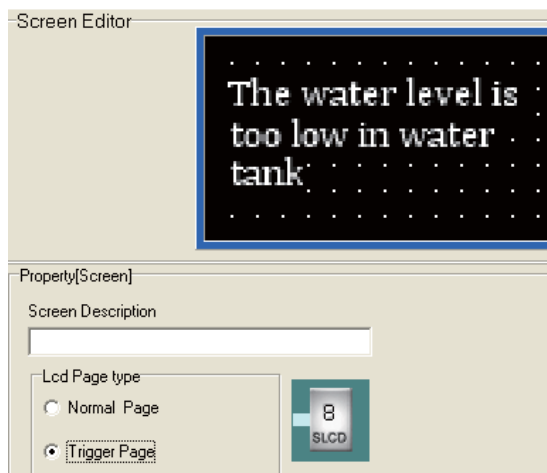

Connect the analog comparator block B0002 to SLCD. When $P1 < 1V$, the analog comparator will output signal and the alarm message will be displayed on PLC display screen.

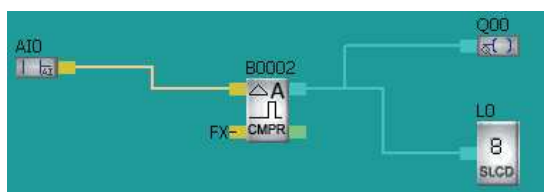

4 2 APB- MHI Structure and Function

4 2 1 APB- HMI Structure

APB operation panel is shown as follow, which is a simple human- machine interface. APB- HMI can modify and set the analog, time and counter parameters in program with its 8 keys, and can monitor running status of PLC input/output; display the analog, time and counter parameter as well.

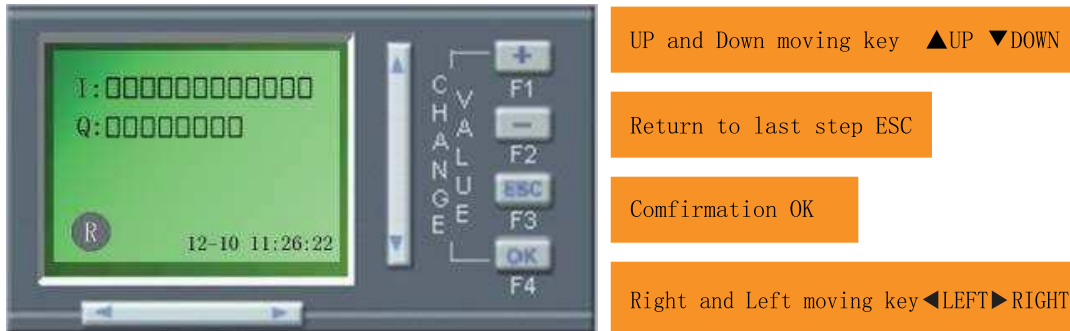

There are 8 keys on APB- HMI: ESC OK $\uparrow\downarrow$ $\leftarrow\rightarrow$ and a 4*10 display panel.

“ $\uparrow\downarrow$ ” keys are mainly used to modify the number at the position of the cursor.

“ ESC ” key is used to return to the interface of last operation.

“ OK ” key is used to confirm the selected menu.

Press “ ESC ” and “ OK ” or “ + ” and “ - ” keys to adjust contrast between light and shade on the screen

“ $\uparrow\downarrow$ ” key is used to move the cursor \blacksquare up and down.

“ $\leftarrow\rightarrow$ ” key is used to switch the main interface icon \square and move the cursor \blacksquare left and right.

4 2 2 APB- SLCD Function

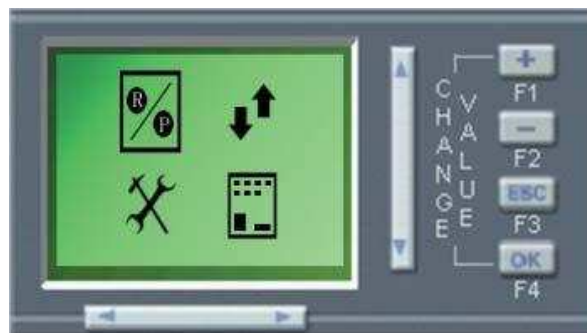

SLCD Main Interface

There are four controls on the display interface:

\mathbb{P} Start/Stop

$\uparrow\downarrow$ Self- defined interface jump

\wrench Program parameters setting

\square I/O status display/ Time and date

Switch the main interface icon with “ $\leftarrow\rightarrow\uparrow\downarrow$ ” keys, and press “ OK ” key to enter the next interface. If there is no any operation on APB- HMI keys within 10 seconds when the main interface is displayed, the main interface will jump to “ I/O Status display ” interface automatically.

1 Start/Stop Operation

Move the main interface icon  to  and press “ OK” key to enter the following interface:



On this interface, change the cursor position by moving “ $\leftarrow \rightarrow$ ” key. Select “ Run” or “ Stop” and press “ OK” key to confirm. Press ESC to return to the main interface.

Prompt Message:

- Run PLC? Indicates “ Is it needed to run PLC?”
- Running Indicates “ PLC is running”
- Stop PLC? Indicates “ Is it needed to stop PLC?”
- Stopped Indicates “ PLC has stopped.”

2 Interface Jump Operation

Move the main interface icon  to  and press “ OK” key to enter the following interface:



On this interface, press “ OK” key to modify the target number that needs to be jumped to.

Press “ ” keys to modify the number at the position of the cursor, and press “ $\leftarrow \rightarrow$ ” keys to move cursor position. Press “ OK” key after modifying the target number. If there is no self- defined interface, the prompt message: “ Error!” will be displayed. Press ESC to return to main interface.

If the interface has been self- defined in the program, it will jump to the corresponding interface. And at this time, you can use “ $\uparrow \downarrow$ ” key to switch to another self- defined interface. Press ESC to return to jump interface.

Note: If the alarm interface is popped up, please press ESC key to return to the main interface. The alarm- triggered time will be displayed reversely if the alarm interface has been checked.

3 Parameter Setting Operation

Move the main interface icon  to  and press “ OK” key to enter the following interface:



On this interface, move the cursor position with “ $\leftarrow \rightarrow \uparrow \downarrow$ ” keys. Select the block parameter (Block), clock parameter (Clock), PLC address (PLC) and version number (Ver), and press “OK” key to confirm. Then press ESC to return the main interface.

Block parameter setting Block

Move the cursor to “Block”, and press “OK” key to confirm. The password protection interface is displayed, and you need to input password of four Arabic numbers. When inputting password, press “ ” key to modify the number at the cursor position, and press “ $\leftarrow \rightarrow$ ” key to move the cursor position.

Prompt message: “Matched” indicates the password is correct. Press any key to enter function block window. Press “ ” key to modify the function block number at the cursor position. Press “ $\leftarrow \rightarrow$ ” key to move the cursor position, and press “OK” key to enter into block parameter modification. Press “OK” key to confirm if a prompt message “Save This” appears after modifying the parameter. If an error occurs to the input data, the prompt message “Fail!” will be displayed on LCD. If the input data is correct, the prompt message “Succeed!” appears. Press any key to return.

Clock parameter setting (Clock)

Move the cursor to “Clock”, and press “OK” key to confirm. Press “ ” key to modify the number at the cursor position, and press “ $\leftarrow \rightarrow$ ” key to move the cursor position.

Press “OK” key for confirmation. The prompt message “Save This” appears after modifying the parameter. Press “OK” key to confirm. If an error occurs to the input data, the prompt message “Data Err!” will be displayed on LCD. If the input data is correct, the prompt message “Succeed!” appears. Press any key to return.

Background light time parameter setting (Light)

Move the cursor to “Light”, and press “OK” key to confirm.

Press “ ” key to modify the number at the cursor position, and press “ $\leftarrow \rightarrow$ ” key to move the cursor position. Press “OK” key for confirmation.

The prompt message “Save This” appears after modifying the parameter. Press “OK” key to confirm. If an error occurs to the input data, the prompt message “Error!” will be displayed on LCD. If the input data is correct, the prompt message “Succeed!” appears. Press any key to return.

Analog calibration Calib

Move the cursor to “Calib”, and press “OK” key to confirm.

The password protection interface is displayed, and you need to input password of four Arabic numbers. Prompt message: “Matched” indicates the password is correct.

Press “+” and “OK” synchronously key to enter analog calibration interface. If the prompt message “Minimum” appears after pressing “OK” key, set the external power supply connected to the analog that needs to be calibrated as 0V, and then press “OK” key to confirm. If the prompt message “Maximum” appears after pressing “OK” key, set the external power supply connected to the analog that needs to be

calibrated as 10V, and then press “ OK” key to confirm.

address setting (PLC)

Move the cursor to “ PLC” , and press “ OK” key to confirm.

Press“ ” key to modify the number at the cursor position, and press“ ← → ” key to move the cursor position. Press “ OK” key for confirmation.

The prompt message “ Save This” appears after modifying the parameter. Press “ OK” key to confirm. If an error occurs to the input data, the prompt message “ Too Large!” will be displayed on LCD. If the input data is correct, the prompt message “ Succeed!” appears. Press any key to return.

Check the version number of system program (Ver)

Move the cursor to “ Ver” , and press “ OK” key to confirm.

4 I/O Status Display

Move the main interface icon  to  and press “ OK” key to enter the following interface:



On this interface, it is able to observe PLC I/O status, and in the meantime, the current system time and PLC running status are displayed. Press“ ↑ ↓ ” key to jump to self- defined interface.

Note: If there is no any operation on APB- HMI keys within 10 seconds when the main interface is displayed, the main interface will jump to “ I/O Status Display” interface automatically.

4 3 Comparison with Conventional Controller LCD

The conventional controller LCD normally can only display simple and fixed interface, such as time, I/O status etc, but the information about timer, counter, and analog etc. can not be displayed. And all interfaces are pre- designed during the design of controller, so that the user is unable to modify, add, and delete interface, even though there is function for modifying parameter, it is still inconvenient for user because of complicated procedure.

Based on these disadvantages mentioned above, we have adopted a new method during the research and development of our APB PLC to offer users a simple, free, and easy- to- use LCD function block, which can implement the following function:

1. Providing 64 self- defined Human- Machine Interfaces

When using APB software, the Human- Machine Interface can be added according to your needs, while the total number can not exceed 64. All self- defined interfaces can be browsed on LCD, or you can press “ ↑ ↓ ” key on the I/O interface to jump to the self- defined interface.

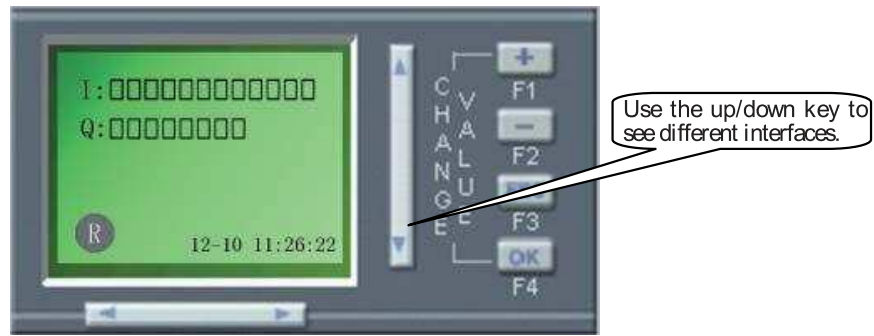

The current value and parameter of various timer, counter, and analog comparator can be displayed on APB-HMI. There are two data displayed on this HMI: Current value and Parameter value. The interface can be modified, added, and deleted according to your needs.

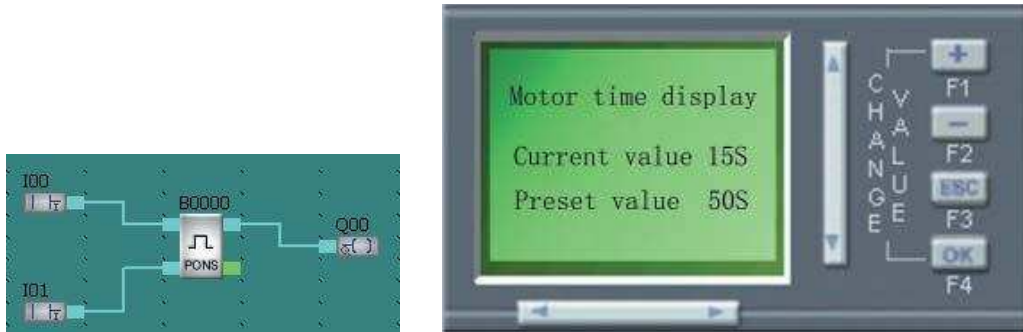

2 Alarm triggering function

When the function block output high level, the linked alarm interface will be activated, and display the alarm- triggered time. The alarm- triggered time will be displayed reversly if the alarm interface has been checked.

The triggering method is shown as follows:



Chapter V APB Technical Parameters

5 1 APB- 22MRA Technical Parameters

Parameter Type	APB- 22MRA
Power	
Power voltage	AC100V 240V
Clock keeping time at 25	160 Hours/6 Months*
Real time accuracy	Max. \pm 20s/month
Digital input:	
General digital input	12 I00 I0B
Input voltage	AC 0V 240V
Input signal 0	AC 0V 40V
Input signal 1	AC 85V 240V
Delay time from 1 to 0	50ms
Delay time from 0 to 1	50ms
Relay output:	
Output points	8 Q00 Q07
Output type	Relay output
Output voltage	AC 0V 240V
	DC 0V 24V
Output current	Resistor load:10A
	Inductive load: 2A
Response time from 1to 0	8ms
Response time from 0 to 1	10ms

Light Load (25,000 Switch Cycle)	1000W AC 230V/240V 500W AC 115V/120V
Fluorescence Light with electronics controlling equipments (25,000 Switch Cycle)	10x58W AC 230V/240V
Fluorescence Tube with conventional compensation (25,000 Switch Cycle)	1x58W AC 230V/240V
Fluorescence Tube without compensation (25,000 Switch Cycle)	10x58W AC 230V/240V
Short circuit protection cos1	Power protection / B16 600A
Short circuit protection cos0.5~0.7	Power protection / B16 600A
Output relay protection	B16 / Max 20A
ON/OFF frequency:	
Mechanical frequency	10Hz
Resistor load/light load	2Hz
Inductive load	0.5Hz

* indicates it is needed to install Li- ion battery.

5 2 APB- 12MRD APB- 22MRD Technical Parameters

Parameter \ Type	APB- 12MRD	APB- 22MRD
Power		
Power voltage	DC 12V 24V	DC 12V 24V
Clock keeping time at 25	160 Hours/6 Months*	160 Hours/6 Months*
Real time clock accuracy	Max. \pm 20s/month	Max. \pm 20s/month
Inputs		
Input points	8 10 17	14 10 10D
Digital inputs	8 10 17	14 10 10D
Analog inputs	8 10 17	12 10 10B

Input voltage range	DC 0V 24V digital inputs	DC 0V 24V digital inputs
	DC 0V 10V(analog inputs)	DC 0V 10V analog inputs
Input signal 0	DC 0V 6.5V	DC 0V 6.5
Input signal 1	DC 7.5V 24V	DC 7.5V 24V
Delay time from 1 to 0	50ms	50ms
Delay time from 0 to 1	50ms	50ms
Relay output		
Output points	4 Q00 Q03	8 Q00 Q07
Output type	Relay Output	Relay Output
Output voltage	AC 0V 240V	AC 0V 240V
	DC 0V 24V	DC 0V 24V
Output current	Resistor load:10A	Resistor load:10A
	Inductive load:2A	Inductive load:2A
Response time from 1 to 0	8ms	8ms
Response time from 0 to 1	10ms	10ms
Light Load (25,000 Switch Cycle)	1000W AC 230V/240V 500W AC 115V/120V	1000W AC 230V/240V 500W AC 115V/120V
Fluorescence Light with electronics controlling equipments (25,000 Switch Cycle)	10x58W AC 230V/240V	10x58W AC 230V/240V
Fluorescence Tube with conventional compensation (25,000 Switch Cycle)	1x58W AC 230V/240V	1x58W AC 230V/240V
Fluorescence Tube without compensation (25,000 Switch Cycle)	10x58W AC 230V/240V	10x58W AC 230V/240V
Short circuit protection cos1	Power protection B16 600A	Power protection B16 600A
Short circuit protection cos 0.5~0.7	Power protection B16 600A	Power protection B16 600A
Relay output protection	B16 Max 20A	B16 Max 20A

ON/OFF frequency		
Mechanical frequency	10Hz	10Hz
Resistor load / light load	2Hz	2Hz
Inductive load	0.5Hz	0.5Hz

5 3 APB- 12MTD APB- 22MTD Technical Parameters

Parameter \ Type	APB- 12MTD	APB- 22MTD
Power:		
Power voltage range	DC 12V 24V	DC 12V 24V
Clock remain time at 25	160 Hours/6 Months*	160 Hours/6 Months*
Real time clock accuracy	Max. \pm 20s/month	Max. \pm 20s/month
Inputs:		
Input points	8 I00 I07	14 I00 I0D
Digital inputs	8 I00 I07	14 I00 I0D
Analog inputs	8 I00 I07	12 I00 I0B
High speed inputs	4 I04 I07	4 I04 I07
Input voltage range	DC 0V 24V digital inputs	DC 0V 24V digital inputs
	DC 0V 10V analog inputs	DC 0V 10V analog inputs
Input signal 0	DC 0V 6.5V	DC 0V 6.5
Input signal 1	DC 7.5V 24V	DC 7.5V 24V
Delay time from 1 to 0	50ms	50ms
Delay time from 0 to 1	50ms	50ms
Transistor outputs:		
Output points	4 Q00 Q03	8 Q00 Q07
High frequency outputs	2 Q02 Q03	2 Q02 Q03
Output type	NPN transistor output	NPN transistor output

Output voltage	DC 0V 24V	DC 0V 24V
Output current	2A	2A
Response time from 1 to 0	8ms	8ms
Response time from 0 to 1	8ms	8ms

5 4 APB- 12MGD APB- 22MGD Technical Parameters

Parameter \ Type	APB- 12MGD	APB- 22MGD
Power:		
Power voltage range	DC 12V 24V	DC 12V 24V
Clock remain time at 25	160 Hours/6 Months*	160 Hours/6 Months*
Real time clock accuracy	Max. \pm 20s/month	Max. \pm 20s/month
Inputs:		
Input points	8 I00 I07	14 I00 I0D
Digital inputs	8 I00 I07	14 I00 I0D
Analog inputs	8 I00 I07	12 I00 I0B
High speed inputs	4 I04 I07	4 I04 I07
Input voltage range	DC 0V 24V digital inputs	DC 0V 24V digital inputs
	DC 0V 10V analog inputs	DC 0V 10V analog inputs
Input signal 0	DC 0V 6.5V	DC 0V 6.5
Input signal 1	DC 7.5V 24V	DC 7.5V 24V
Delay time from 1 to 0	50ms	50ms
Delay time from 0 to 1	50ms	50ms
Transistor outputs:		
Output points	4 Q00 Q03	8 Q00 Q07
High frequency outputs	2 Q02 Q03	2 Q02 Q03
Output type	Transistor output	Transistor output

Output voltage	DC 0V 24V	DC 0V 24V
Output current	2A	2A
Response time from 1 to 0	8ms	8ms
Response time from 0 to 1	8ms	8ms

5 5 APB- 22ERA/APB- 22ERD/APB- 22ETD/APB- 22EGD Extension Module Technical Parameters

1. APB- 22ERA Technical Parameters

Parameter	Type	APB- 22ERA
Power		
Power voltage		AC 100V- 240V
Digital input:		
Input points		14 I10 - I1D
General digital input		14 I10 - I1D
Input voltage		AC 0V - 240V
Input signal 0		AC 0V - 40V
Input signal 1		AC 85V - 240V
Delay time from 1 to 0		50ms
Delay time from 0 to 1		50ms
Relay output:		
Output points		8 Q00 - Q07
Output type		Relay output
Output voltage		AC 0V - 240V / DC 0V - 24V
Output current		Resistor load:10A / Inductive load: 2A
Response time from 1to 0		8ms
Response time from 0 to 1		10ms

Light Load (25,000 Switch Cycle)	1000W AC (230V/240V) 500W AC(115V / 120V)
Fluorescence Light with electronics controlling equipments (25,000 Switch Cycle)	10 * 58W AC 230V / 240V
Fluorescence Tube with conventional compensation (25,000 Switch Cycle)	1 * 58W AC 230V / 240V
Fluorescence Tube without compensation (25,000 Switch Cycle)	10 * 58W AC 230V / 240V
Short circuit protection cos1	Power protection B16 600A
Short circuit protection cos0.5~0.7	Power protection B16 600A
Output relay protection	B16 Max 20A
ON/OFF frequency:	
Mechanical frequency	10Hz
Resistor load/light load	2Hz
Inductive load	0.5Hz

2. APB- 22ERD Technical Parameters

Parameter \ Type	APB- 22ERD
Power	
Power voltage	DC 12V - 24V
Inputs:	
Input points	14 I10 - I1D
Digital inputs	14 I10 - I1D
Input voltage	DC 0V 24V (digital inputs)
Input signal 0	DC 0V - 5V
Input signal 1	DC 10V - 24V
Delay time from 1 to 0	50ms

Delay time from 0 to 1	50ms
Relay output:	
Output points	8 Q00 - Q07
Output type	Relay output
Output voltage	AC 0V - 240V / DC 0V - 24V
Output current	Resistor load:10A / Inductive load: 2A
Response time from 1to 0	8ms
Response time from 0 to 1	10ms
Light Load (25,000 Switch Cycle)	1000W AC (230V/240V) 500W AC(115V / 120V)
Fluorescence Light with electronics controlling equipments (25,000 Switch Cycle)	10 * 58W AC 230V / 240V
Fluorescence Tube with conventional compensation (25,000 Switch Cycle)	1 * 58W AC 230V / 240V
Fluorescence Tube without compensation (25,000 Switch Cycle)	10 * 58W AC 230V / 240V
Short circuit protection cos1	Power protection B16 600A
Short circuit protection cos0.5~0.7	Power protection B16 600A
Output relay protection	B16 Max 20A
ON/OFF frequency:	
Mechanical frequency	10Hz
Resistor load/light load	2Hz
Inductive load	0.5Hz

3. APB- 22ETD Technical Parameters

Parameter \ Type	APB- 22ETD
Power	
Power voltage	DC 12V - 24V

Inputs:	
Input points	14 I10 - I1D
Digital inputs	14 I10 - I1D
Input voltage	DC 0V - 24V
Input signal 0	DC 0V - 5V
Input signal 1	DC 10V - 24V
Delay time from 1 to 0	50ms
Delay time from 0 to 1	50ms
Transistor output:	
Output points	8 Q00- Q07
Output type	NPN transistor output
Output voltage	DC 0V - 24V
Output current	2A
Response time from 1to 0	8ms
Response time from 0 to 1	8ms

4. APB- 22EGD Technical Prameters

Parameter	Type	APB- 22EGD
Power		
Power vdtage		DC 12V - 24V
Inputs:		
Input points		14 I10 - I1D
Digital inputs		14 I10 - I1D
Input voltage		DC 0V - 24V
Input signal 0		DC 0V - 5V
Input signal 1		DC 10V - 24V
Delay time from 1 to 0		50ms

Delay time from 0 to 1	50ms
Transistor output:	
Output points	8 Q00 - Q07
Output type	NPN transistor output
Output voltage	DC 0V - 24V
Output current	2A
Response time from 1to 0	8ms
Response time from 0 to 1	8ms

5. APB- 24MRD Technical Parameters

Type Parameter	APB- 24MRD
Power	
Power voltage range	DC 12V 24V
Clock remain time at 25	160 Hours/6 Months*
Real time clock accuracy	Max. \pm 20s/month
Inputs:	
Input points	14 I0 ID
Digital inputs	14 I0 ID
Analog inputs	14 I0 ID
High speed inputs	4 I04 I07
Input voltage range	DC 0V 24V digital inputs
	DC 0V 10V analog inputs
Input signal 0	DC 0V 6.5V
Input signal 1	DC 7.5V 24V
Delay time from 1 to 0	50ms
Delay time from 0 to 1	50ms

Current signal input	2 IA0 IA1
Input current range	0mA 20mA
outputs:	
Analog outputs	2 Q0 Q1
Output range	4mA 20mA analog
Digital outputs	6 Q2 Q07
Output type	Relay output
Output voltage	AC 0V 240V
	DC 0V 24V
Output type	Resistor load:10A
	Inductive load: 2A
Response time from 1to 0	8ms
Response time from 0 to 1	10ms
Light Load (25,000 Switch Cycle)	1000W AC 230V/240V 500W AC 115V/120V
Fluorescence Light with electronics controlling equipments (25,000 Switch Cycle)	10x58W AC 230V/240V
Fluorescence Tube with conventional compensation (25,000 Switch Cycle)	1x58W AC 230V/240V
Fluorescence Tube without compensation (25,000 Switch Cycle)	10x58W AC 230V/240V
Short circuit protection cos1	Power protection B16 600A
Short circuit protection cos0.5~0.7	Power protection B16 600A
Output relay protection	B16 Max 20A
ON/OFF frequency:	
Mechanical frequency	10Hz
Resistor load/light load	2 Hz
Inductive load	0.5Hz

5 6 APB Series General Technical Parameter

Items	Standard	Conditions
Weather environment:		
Environmental temperature	Cold: IEC- 68- 2- 1	
	Hot: IEC- 202	
Horizon installation Vertical installation		0 to 55 0 to 55
Storage / transportation		- 40 to +70
Relative humidity	IEC68- 2- 30	From 5% to 95% without condensation
Air pressure		From 795 to 1080Kpa
Pollution	IEC68- 2- 42 IEC- 68- 2- 43	SO ₂ 10cm ³ /m ³ , 4 days H ₂ S 1CM ² /m ³ , 4 days
Mechanical conditions:		
Protection type	54	IP20
Vibration	IEC68- 2- 6	From 10 to 57Hz (constant ibration length at 0.15mm) From 57 to 150Hz (constant acceleration speed 2g)
Brunt	IEC68- 2- 27	18 times half sine 15g/11ms
Fall	IEC68- 2- 31	Falling high 50mm
Free falling down (with package)	IEC68- 2- 32	1m
EMC:		
Static electricity discharge	Level 3	8Kv air discharge, 6kV/contact discharge
Electromagnetic field	IEC801- 3	Field density 10V/M
Anti- interference	EN55011	Limit class B 1
Surge Pulse	IEC801- 4 Level 3	2KV power line 2KV signal line
IEC/VDE safety		
Insulation density	IEC1131	Reach requirements

Chapter VI Application

APB has a very wide application range. In order to help the user to further understand the wide potential application of APB and the convenience brought about from its use, we will show some common and typical control schemes herein. After the user has read these application examples, it will be clear how simple it is to use APB to establish automatic control requirements, especially in a system requiring time control and in the automatic control of intelligent living quarters etc.

6 1 The Illumination of Multifunction Switch in Stairs, Halls etc

Requirements:

1. When the light switch has been pressed, the illumination will be connected and then be cut off automatically after the set time of 3 minutes.
2. Lights glimmer for 5 seconds before being switched off.
3. When the switch is pressed again within 5 seconds, the illumination will be on as usual.
4. When the switch is pressed and held for more than 5 seconds, the illumination will be cut off
5. The illumination will be automatically connected every day at PM6:30 and be cut off every day at AM6:30.

The Program Diagram is shown as follow:

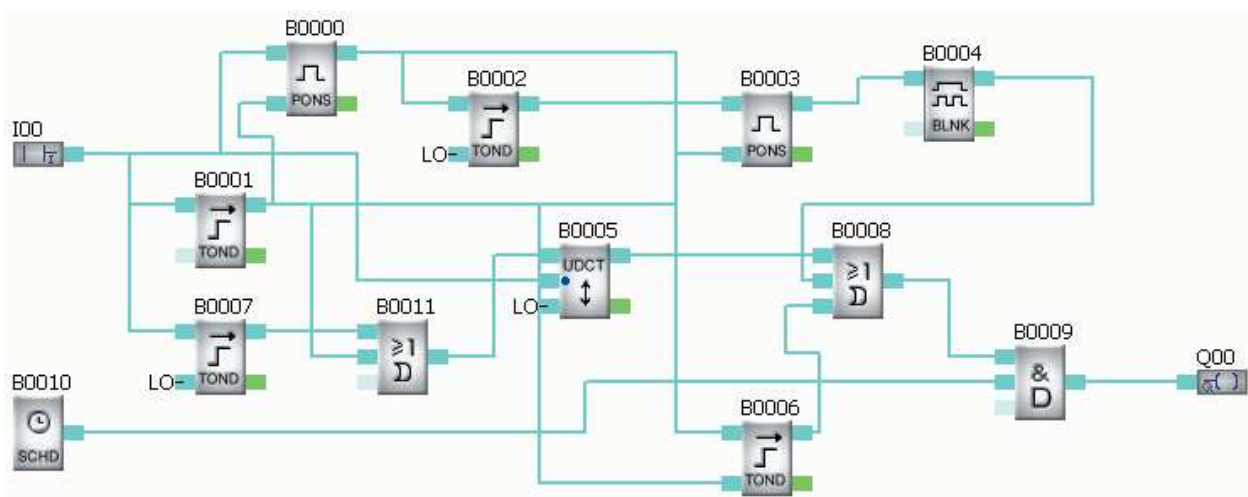

6 2 Automatic Gate Control Requirements

Requirements:

1. Opening and closing of the gate shall be controlled by the guard in the control room.
2. Normally the gate shall be open or closed completely, but the opening and closing action can be interrupted at any time.
3. The alarm lamp shall begin to flash when the gate acts and shall keep flashing as long as the gate continues to move.
4. A pressure damper shall be provided so that the gate can be automatically open when it touches a person or an article.

The Program Diagram is shown as follow:

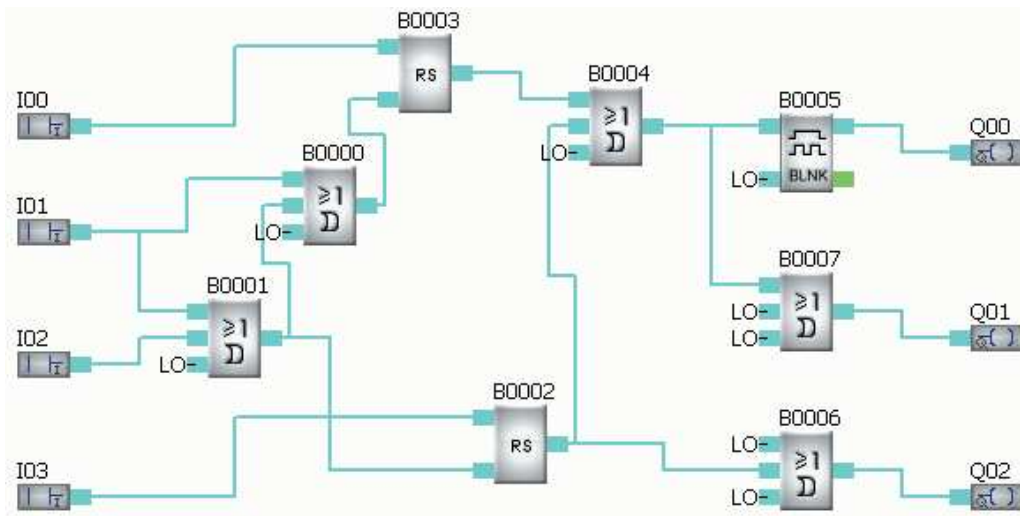

Note:

- I00 to the gate- open switch;
- I01 to the gate- stopped switch;
- I02 to the safety pressure damper;
- I03 to the gate- closed switch;
- QA0 to the flashing lamp;
- QA1 to the gate- open motor contactor;
- QA2 to the gate- closed motor contactor;

6 3 Illumination System for Display Windows

Requirements:

1.1 Basic lighting for the display period:

a Time

Monday to Friday 8 : 00 ~ 22 : 00;

On Saturday 8 : 00 ~ 24 : 00;

On Sunday 9 : 00 ~ 20 : 00;

b Automatic on/off: the basic lighting can be automatically turned off whilst maintaining minimum illumination and display lighting.

1.2 Additional requirements for night lighting:

a Time

Monday to Friday light sensitive switch is triggered at 22 : 00;

On Saturday light sensitive switch is triggered at 24 : 00;

On Sunday light sensitive switch is triggered at 20 : 00;

b Light sensitive switch triggering/ automatic off: can automatically turn off the minimum illumination and the display lamps when it is on and can also automatically turn on the minimum illumination and display lighting when it is off.

1.3 Minimum illumination and display lighting in non- display period:

The minimum illumination and the display lighting shall be maintained and shall be automatically turned

on when the display period ends and the basic lighting and night lighting are turned off.

1.4 Test switch:

All lamp groups can be tested when the test switch is pressed.

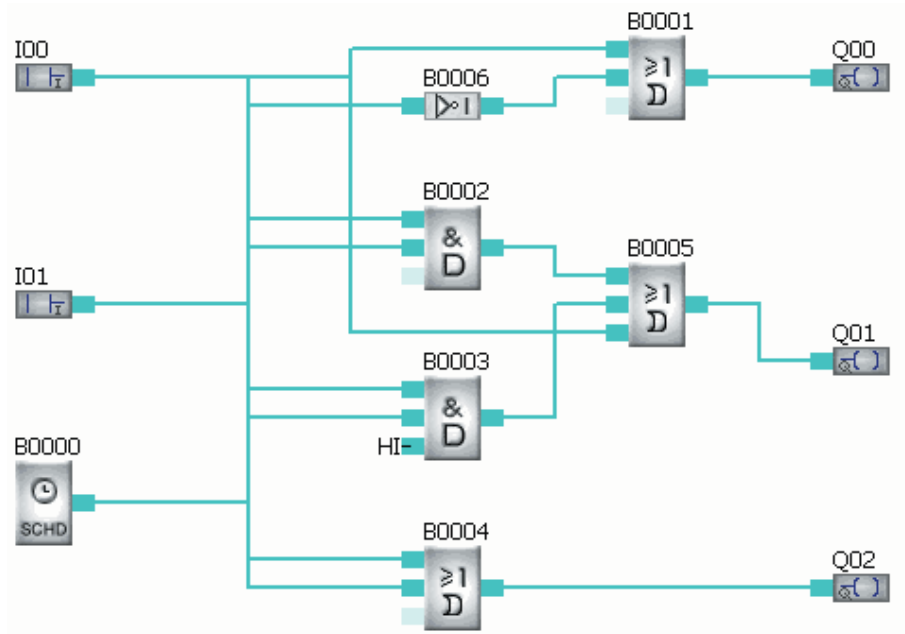

Note:

- I0 to the test switch;
- I1 to the light sensitive switch
- Q00 to the basic lighting in non- display period;
- Q01 to the night additional lighting within display period;
- Q02 to the basic lighting during display period;

APPENDIX A APB MODBUS RTU Introduction

APB MODBUS Protocol Address Type and Function Code List (Note1)

PLC Parameter	Supported Address	R/W Attribute	Function Code	Operation Type	Remarks
I0~I127	100 — 17F	R	0 x 01	0 x bit	Read input status I
Q0~Q255	200 — 2FF	R/W	0 x 01 0 x 05	0 x bit	Read and write output status Q
M0~M1999	2600 — 2DCF	R/W	0 x 01 0 x 05	0 x bit	Read and write M status
AI0~AI15	4600 — 460F	R	0 x 03	4 x word	Read analog input AI
AQ0~AQ15	4680 — 468F	R/W	0 x 03 0 x 10	4x 5x word	Read and write analog output AQ
AM0~AM127	4700 — 477F	R/W	0 x 03 0 x 10	4x 5x word	Read and write analog register AM
D0~D511	4800 — 49FF	R/W	0 x 03 0 x 10	5x word	Read and write register D(Note8)
B0 ~ B319	8000 — BFFF	R/W	0 x 03 0 x 10	4x 5x word	Read and write function block parameters (Note2)
	C000 — FFFF	R	0 x 03	4x	Read and write function block parameters (Note3)
	Clock switch parameters' address (calculated independently)	R/W	0 x 41 0 x 42		Read and write the parameters of clock switch block (Note4)
PLC address	7FFF	R/W	0 x 03 0 x 10	4 x 5x word	Read and write PLC address (Note5)
PLC status	0	R	0 x 01	0 word	Read PLC status (Note6)
PLC time year month day hour minute Second	7FF9 — 7FFE	R/W	0 x 03 0 x 10	4x 5x word	Read and write real- time clock RTC (Note7)

Note1: Except for clock function block, all read and write operations of APB MODBUS RTU communication protocol are standard MODBUS RTU commands, which can communicate with devices that support MODBUS RTU.

Communication parameters: 9600bps, 8 data bits, 1 stop bit, and no parity.

The time interval between frames is 50ms.

Note2: When reading PLC status, only the bit0 at address0 can be read now to indicate running or stop status of PLC. 1: running, 0: stop.

Note3: When reading and writing function block parameters, the address calculation formula is: (block number * 32 + block parameter number * 4) + 0x8000

The block parameter is numbered from 0. They are 0, 1, 2, 3 respectively.

The address calculation formula for clock switch block is: block number * 256 + group number * 8

The group is numbered from 0, and 32 groups at most.

Note4: When reading the block running value, the address calculation formula is: (block number * 32 + block parameter number * 4) + 0xC000

Now only one running value for each block, and the parameter number is 0.

Note5: When reading and writing PLC address, the MODBUS address range is from 0 to 254, and only low byte of a word is valid.

Note6: When reading PLC status, only the bit0 at address0 can be read now to indicate running or stop status of PLC. 1: running, 0: stop.

Note7: When reading real- time clock, at most 4 words can be read, and 4 words must be written when writing real- time clock. Writing format is: year, month, day, week, hours, minutes and seconds. Sunday~ Saturday is written as 00~ 06.

Example: If write 2009- 12- 15 Friday 10:40:30, then the request frame should be: 01 10 7F F9 00 04 08 20 09 12 15 05 10 40 30 E7 2C.

Note8: Select “ 4x” as Register address type to read or write double Register. the low address Register contains the data high order bit and the high address Register contains the low order bit.

Select “ 5x” as Register address type to read or write double Register. the low address Register contains the data low order bit and the high address Register contains the high order bit.

When reading and writing APB DW Registers by MODBUS RTU. “ 5x” must be used.

The DW MODBUS Protocol Address List

DW Register	D Register	MODBUS Address H
DW0	D0	4800
	D1	4801
DW1	D2	4802
	D3	4803
DW2	D4	4804
	D5	4805
DW3	D6	4806
	D7	4807
DW4	D8	4808
	D9	4809
DW255	D510	67FE
	D511	67FF

1 Examples for Read/Write Operation

Example1: Read/Write On- delay Block Parameter

If block number is B0000, and parameter number is 0, then the address is 0x8000 calculated by the formula: $0 * 32 + 0 * 4 + 0x8000$. Parameter value occupies 2 words.

Read on- delay time parameter 1S(1000MS). It is 0000 03E8 in HEX.

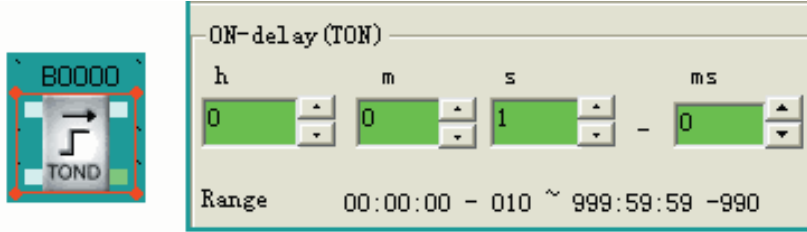

When read time parameter, MODBUS RTU command frame should be:

Request Message	
Field Name	Example (Hex)
Device address	01
Function code	03
High byte of the block address	80
Low byte of the block address	00
High byte of the block parameter value	00
Low byte of the block parameter value	02
CRC low byte	ED
CRC high byte	CB

Response Message	
Field Name	Example (Hex)
Device address	01
Function code	03
The number of returned bytes	04
Parameter value of the block	00
Parameter value of the block	00
Parameter value of the block	03
Parameter value of the block	E8
CRC low byte	FA
CRC high byte	8D

Write on- delay time parameter 3minutes and 20seconds. It is 200000ms, 0003 0D40 in Hex.

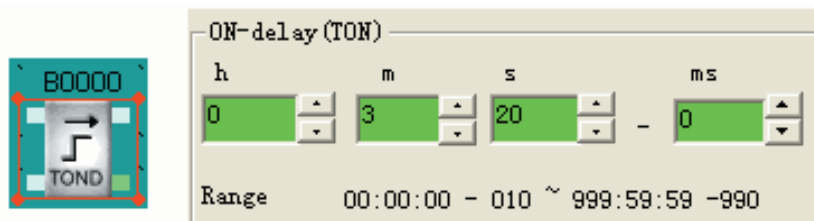

When write time parameter, MODBUS RTU command frame should be:

Request Message	
Field Name	Example (Hex)
Device address	01
Function code	10
High byte of the block address	80
Low byte of the block address	00
High byte of the block parameter value	00
Low byte of the block parameter value	02
The number of written bytes	04

Response Message	
Field Name	Example (Hex)
Device address	01
Function code	10
High byte of the block address	80
Low byte of the block address	00
High byte of the block parameter	00
Low byte of the block parameter	02
CRC low byte	68

Parameter value of the block	00	CRC high byte	08
Parameter value of the block	03		
Parameter value of the block	0D		
Parameter value of the block	40		
CRC low byte	ED		
CRC high byte	CB		

Example2: Read/Write the parameter of universal counter block

If block number is B0000, and parameter number is 0, then the address is 0x8000 calculated by the formula: $0 * 32 + 0 * 4 + 0x8000$. Parameter value occupies 2 words.

Read the universal counter parameter 12345678. It is 00BC 614E (HEX).

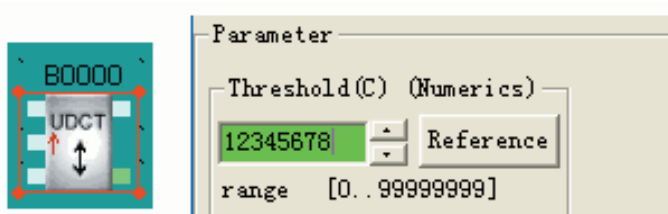

When read counter parameter, MODBUS RTU command frame should be:

Request Message		Response Message	
Field Name	Example (Hex)	Field Name	Example (Hex)
Device address	01	Device address	01
Function code	03	Function code	03
High byte of the block address	80	The number of returned bytes	04
Low byte of the block address	00	Parameter value of the block	00
High byte of the block parameter value	00	Parameter value of the block	BC
Low byte of the block parameter value	02	Parameter value of the block	61
CRC low byte	ED	Parameter value of the block	4E
CRC high byte	CB	CRC low byte	92
		CRC high byte	73

Write the allowed maximum value 9999 9999 to universal counter. It is 05F5 E0FF in HEX.

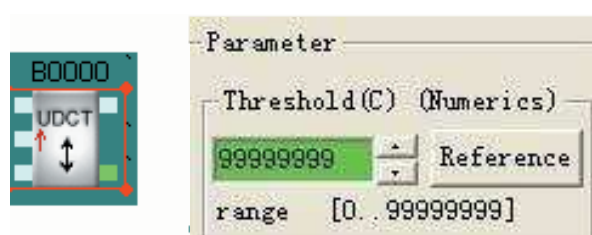

When write counter parameter, MODBUS RTU command frame should be:

Request Message	
Field Name	Example (Hex)
Device address	01
Function code	10
High byte of the block address	80
Low byte of the block address	00
High byte of the block parameter value	00
Low byte of the block parameter value	02
The number of written bytes	04
Parameter value of the block	05
Parameter value of the block	F5
Parameter value of the block	E0
Parameter value of the block	FF
CRC low byte	8B
CRC high byte	17

Request Message	
Field Name	Example (Hex)
Device address	01
Function code	10
High byte of the block address	80
Low byte of the block address	00
High byte of the block parameter value	00
Low byte of the block parameter value	02
CRC low byte	68
CRC high byte	08

Example3: Read the parameters of analog monitor

The block number is 5. Its parameters include field value1, and field value2.scale factor, offset value, The parameters numbers are 0, 1, 2, and 3 respectively.

The address is calculated according to the formula: block number * 32 + parameter number * 4 + 0x8000.

Responding address for field value 1 is 0x80A0;

Responding address for field value2 is 0x80A4;

Responding address for scale factor is 0x80A8;

Responding address for offset value is 0x80AC;

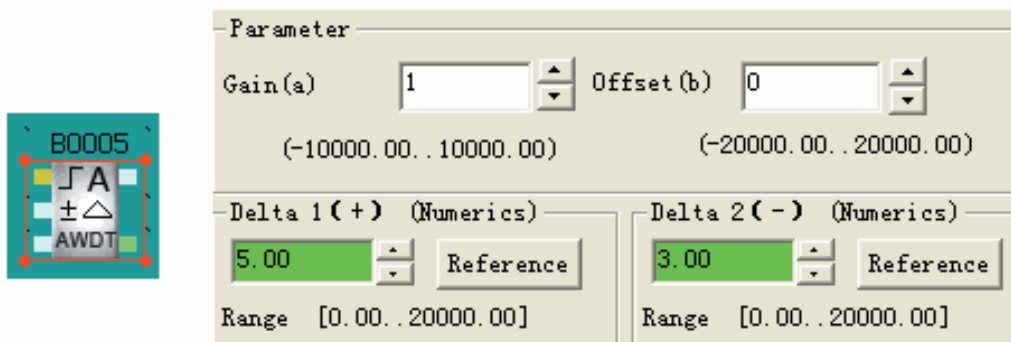

When read parameter 1, the scale factor of analog monitor block, MODBUS RTU command frame should be:

Request Message	
Field Name	Example (Hex)
Device address	01
Function code	03

Request Message	
Field Name	Example (Hex)
Device address	01
Function code	03

High byte of the block address	80
Low byte of the block address	A8
High byte of the block parameter value	00
Low byte of the block parameter value	02
CRC low byte	ED
CRC high bite	E9

The number of returned bytes	04
Parameter value of the block	00
Parameter value of the block	00
Parameter value of the block	00
Parameter value of the block	64
CRC low byte	FB
CRC high bite	D8

The set value 1 in APB software will become 100 times larger than the actual value when it is read through MODBUS protocol.

Example4: Read the running value of analog monitor block

If block number is 5, and parameter number is 0, then the address is 0xC0A0 calculated by the formula: $(0 * 32 + 0 * 4) + 0xC000$. Parameter value occupies 2 words.

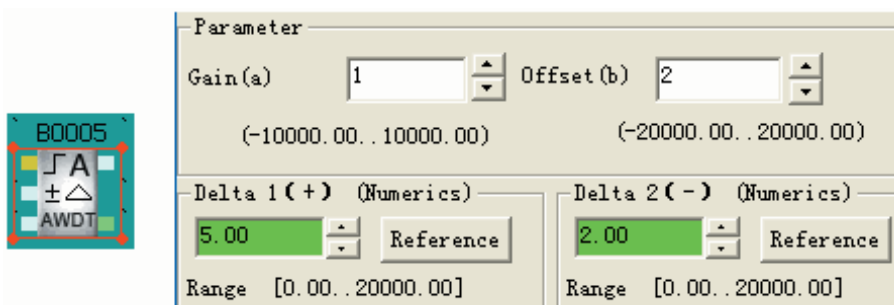

If the input value is 10V, then the theoretical value will be 12 according to the calculation formula: actual value = $(AIx \cdot \text{gain value}) + \text{offset}$, and the actual value is 12.01.

The read value through MODBUS protocol is 1201, which is 04B1 in HEX.

MODBUS RTU command frame should be:

Request Message	
Field Name	Example (Hex)
Device address	01
Function code	03
High byte of the block address	C0
Low byte of the block address	A0
High byte of the block parameter value	00
Low byte of the block parameter value	02
CRC low byte	F8
CRC high bite	E9

Response Message	
Field Name	Example (Hex)
Device address	01
Function code	03
The number of returned bytes	04
Parameter value of the block	00
Parameter value of the block	00
Parameter value of the block	04
Parameter value of the block	B1
CRC low byte	38
CRC high bite	87

Example5: Read the running value of off- delay block



If block number is 1, and parameter number is 0, then the address is 0xC020 calculated by the formula: $(0 * 32 + 0 * 4) + 0xC000$. Parameter value occupies 2 words.

If the running value is 24seconds and 570ms, its decimal value is 24570, and

corresponding hexadecimal value is 5FFA.

MODBUS RTU command frame should be:

Request Message	
Field Name	Example (Hex)
Device address	01
Function code	03
High byte of the block address	C0
Low byte of the block address	20
High byte of the block parameter value	00
Low byte of the block parameter value	02
CRC low byte	F9
CRC high bite	C1

Request Message	
Field Name	Example (Hex)
Device address	01
Function code	03
The number of returned bytes	04
Parameter value of the block	00
Parameter value of the block	00
Parameter value of the block	5F
Parameter value of the block	FA
CRC low byte	43
CRC high bite	80

2 Detailed Explanation on Clock Block Operation:

When read/write the clock block parameters, the self- defined function codes are used, and the request/ response format is similar to the function codes 0x03, 0x10 of the standard MODBUS RTU.

It is only allowed to read and modify the time of clock block with this command, while the time group cannot be added. In other words, the operation can be executed to the existed time only.

Example1: Read parameters of the clock block



time setting				
Item	State	Date	Time	Week
0	ON	2009-12-8	17:05:21	----

If block number is 0, and read the data of number 0, then the address is calculated by the formula: block number * 256 + group number * 8 = 0. Parameter value occupies 4 words.

If the time data of item 0 is 2009- 12- 8 17:05:21, and stays in ON state, then MODBUS RTU command frame should be:

Request Message	
Field Name	Example (Hex)
Device address	01
Function code	41
High byte of the block address	00
Low byte of the block address	00
High byte of the block parameter value	00

Request Message	
Field Name	Example (Hex)
Device address	01
Function code	41
The number of returned bytes	08
If clock switch is in ON state, the value is 01; If clock switch is in OFF state, the value is 00;	01

Low byte of the block parameter value	04	Clock switch mode (see note1)	01
CRC low byte	3C	Clock switch date Year	09
CRC high bite	06	Clock switch date Month	12
		Clock switch date Day	08
		Clock switch date Hour	17
		Clock switch date Minute	05
		Clock switch date Second	21
		CRC low byte	2E
		CRC high bite	73

Note1: Clock switch mode:

- 01 indicates year
- 02 indicates month
- 03 indicates day
- 04 indicates the fixed date
- 05~11 indicates from Monday to Sunday
- 12 indicates from Monday to Thursday
- 13 indicates from Monday to Friday
- 14 indicates from Monday to Saturday
- 15 indicates from Friday to Sunday
- 16 indicates from Saturday to Sunday

Example2: Modify the data of clock block

The block number is 2, and the clock switch mode is the fixed mode.

Modify the time data of number 1 to be 2009- 7- 30 08:08:59, and the state is ON.

The address is calculated by the formula: block number * 256 + group number * 8. $2 * 256 + 1 * 8 = 520$, and the corresponding hexadecimal value is 0x208.



time setting				
Item	State	Date	Time	Week
0	OFF	2009-7-16	14:35:32	----
1	ON	2009-7-30	08:08:59	----

MODBUS RTU command frame should be:

Request Message	
Field Name	Example (Hex)
Device address	01
Function code	42
High byte of the block address	02

Request Message	
Field Name	Example (Hex)
Device address	01
Function code	42
High byte of the block address	02

APB- SMS Module

1 Structure of APB- SMS Module



- Input of power Supply Input wiring terminal Mode knob switch Antenna Communication interface
- Red and green indicator Software download interface Output wiring terminal

2 Installation Dimensions

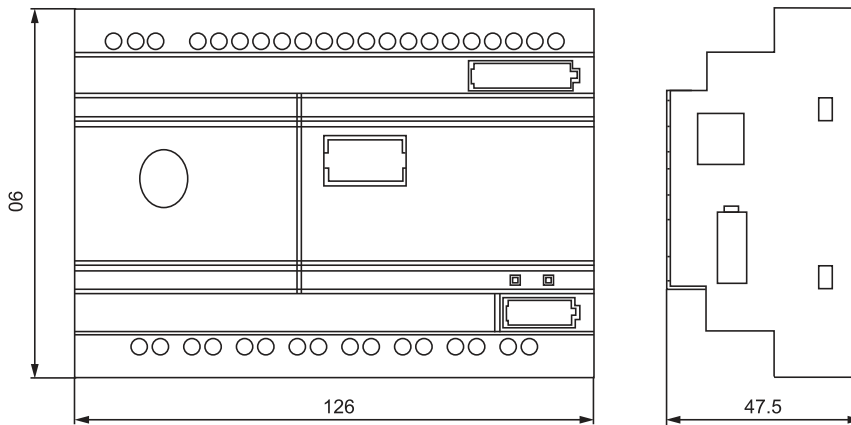

3 The Specifications of APB- SMS

The type of APB- SMS	Quad Band
APB- SMS- C	Quad Band: EGSM 900/DCS 1800
APB- SMS- E	Quad Band: GSM 850/EGSM 900/DCS 1800/PCS 1900

4 Work mode

The work mode can be switched by the knob in SMS module

Mode 0: short message alarming function, mode indicator light is off when GSM network has not

been detected the red indicator flickers quickly and the flicker cycle is 200MS when GSM network has been detected the flicker cycle is 2~4S. the green indicator is used to indicate the communication status,when it communicates with APB PLC normally the flicker cycle is 2S if no communication between APB- SMS and APB PLC the flicker cycle is 200MS.

Mode 1: Receiving and sending short message by configuring software. indicator light is on.

When APB- SMS works in mode 1 the red indicator is normally on.

5 Functions of APB- SMS

APB- SMS is used independently

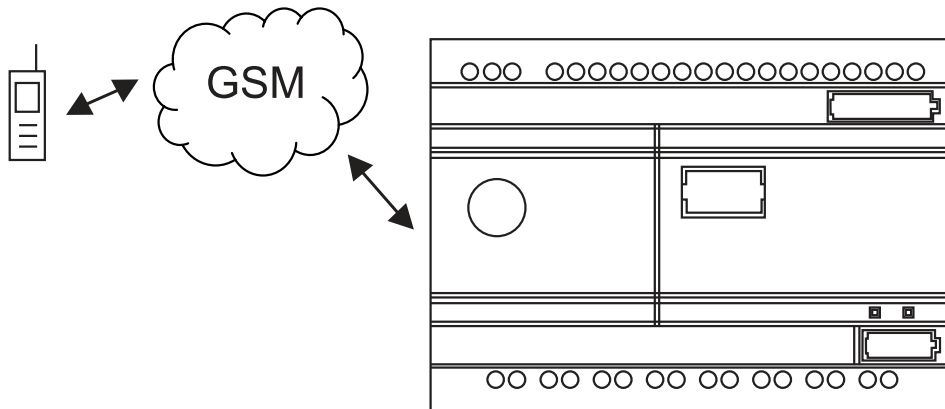

When SMS works in mode 0. Input signal SI1 has message alarming function. When the high level is triggered, the message“ I1ON” will be sent to the target number to alarm The input and output state can be inquired and SQ1 can be set by sending the mobile phone instruction. Input signal SI0 controls the output SQ0 directly. The SQ0 delay ON OFF time can be set by GSMMODULE software.

When SMS works in mode 1. the short message can be sent and received by GSMMODULE software

APB- SMS connecting with APB PLC

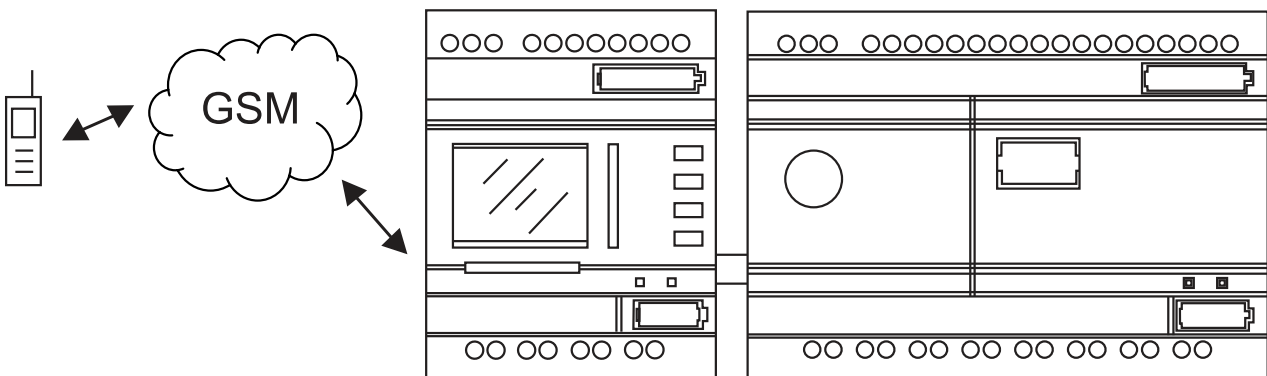

When SMS works in mode 0 APB PLC input state can be inquired and output state. time and count parameter. analog parameter can be inquired and set by sending the mobile phone instruction. The alarm message can be sent to user mobile phone by programming SMS function block in APB software.

When SMS works in mode 1. the short message can be sent and received by GSMMODULE software.

6 Technical Parameters

- Operation power: DC12~24V
- Operation frequency:
- Operation temperature: - 10 +55
- Operation humidity: 0 90%
- Interface rate: 9600Bps
- Interface standard: RS232
- Overall dimensions: 126mm* 90mm* 47.5mm
- Weight: 450g

7 Parameter Settings:

- Knob in SMS rotates to mode0.SMS work under the mode of short message alarming. Open the SMS parameter configuring software GSMMODULE .exe and configure the parameter

Double click  to open SMS setting tool;

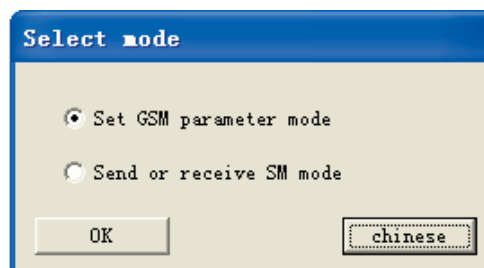

Choose the proper COM port, and click “ **Open Port** ” .

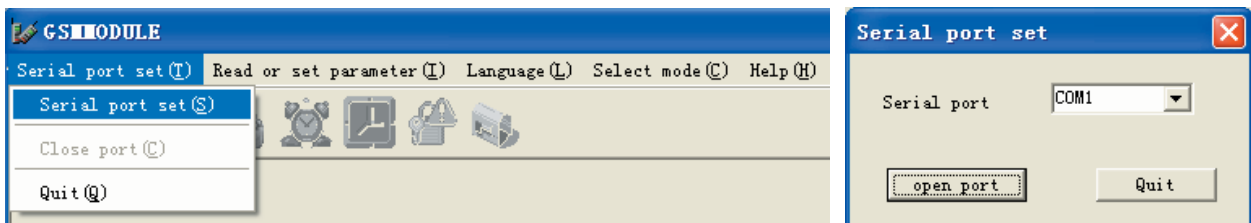

Input old password first and then input new password when the password is set .the password has 8bits at most. If the password is forgotten, please use “ **Restore factory settings**” to clear all parameters. Click “ **Set Password** ” to download new password to SMS module.

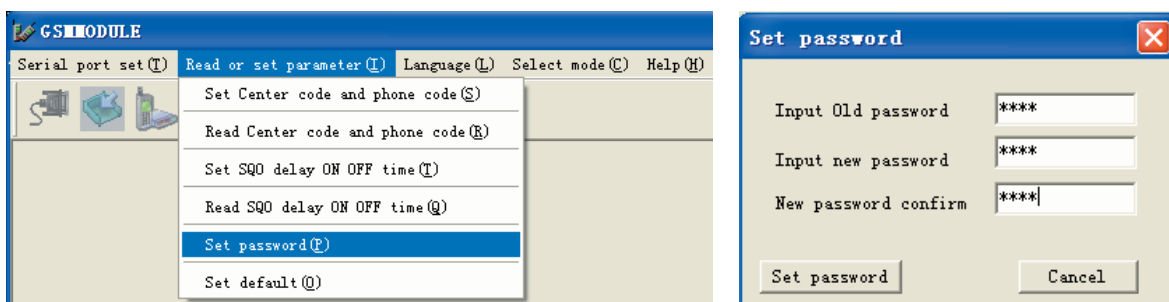

Click “ Set SQ0 delay ON OFF time”

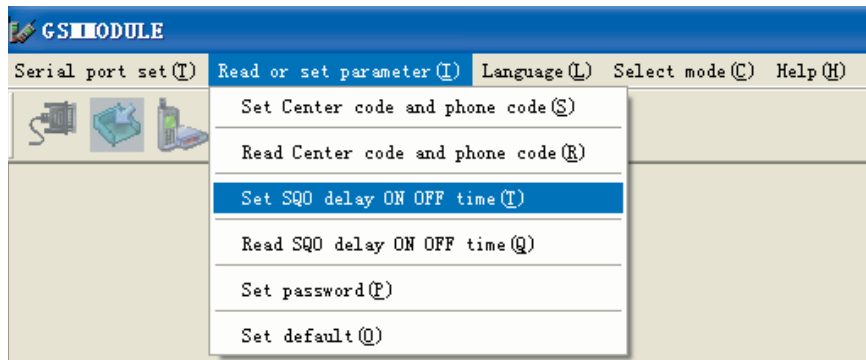

Input SQ0 Delay ON time Click “ Set Delay ON time ” and download Delay ON time to SMS module.

Input SQ0 Delay OFF time Click “ Set Delay OFF time ” and input correct password download Delay ON time to SMS module.



Click “ Read SQ0 delay ON OFF time”

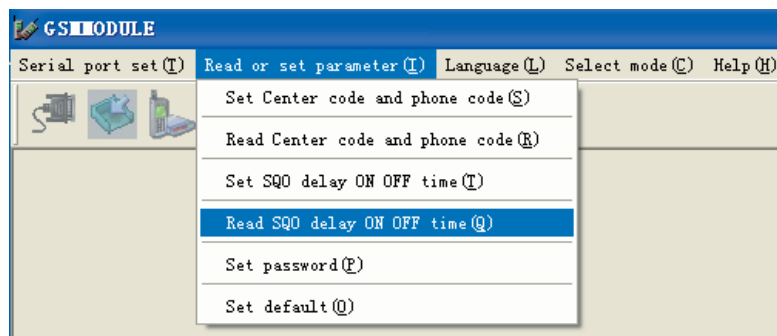

Input SQ0 Delay ON time Click “ Read SQ0 delay ON time ” and download Delay ON time to SMS module.

Input SQ0 Delay OFF time Click “ Read SQ0 delay OFF time ” and input correct password download Delay ON time to SMS module.



Click “ Set center code and phone code”

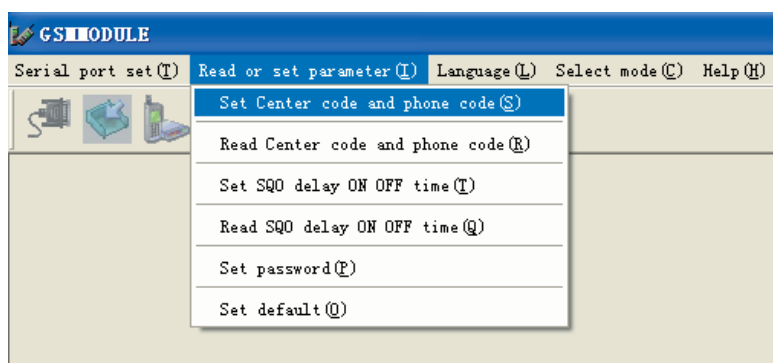

Input SMS center number and SMS mobile number. SMS center number is 20bits at most. It is the operating agencies message service center number of SIM card in SMS module, e.g.: 861380025500. “ SMS mobile number” : 20 bits at most. If it is not set, no any message will be sent when there is the alarm.

Click “ Set Center Code” , input correct password and download the SMS center number to SMS module.

Click “ Set Phone Code” , input correct password and download mobile number to SMS module.

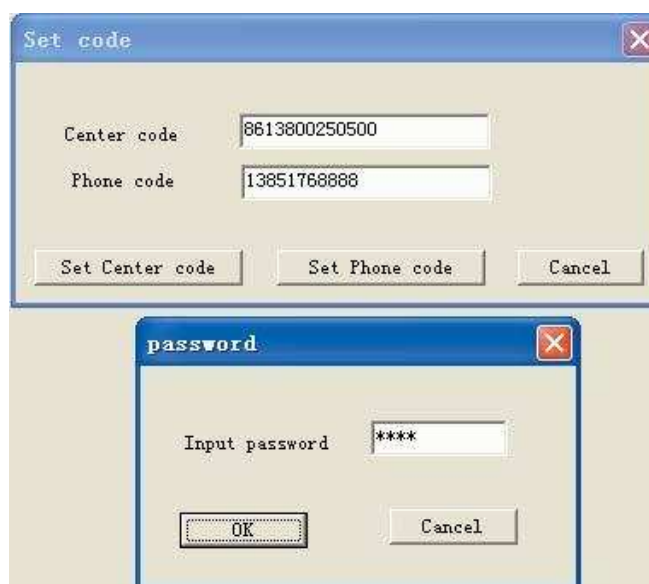

Click “ Read center code and phone code”

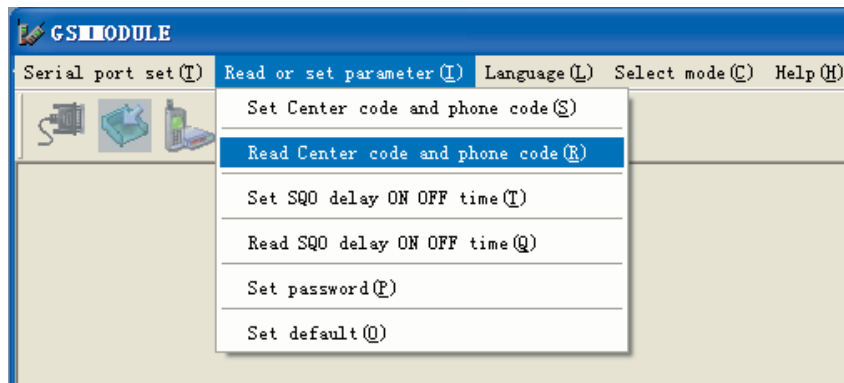

Click “ Read Center Code” input correct password to read SMS center number from SMS module.

Click “ Read Phone Code” input correct password to read mobile number from SMS module.

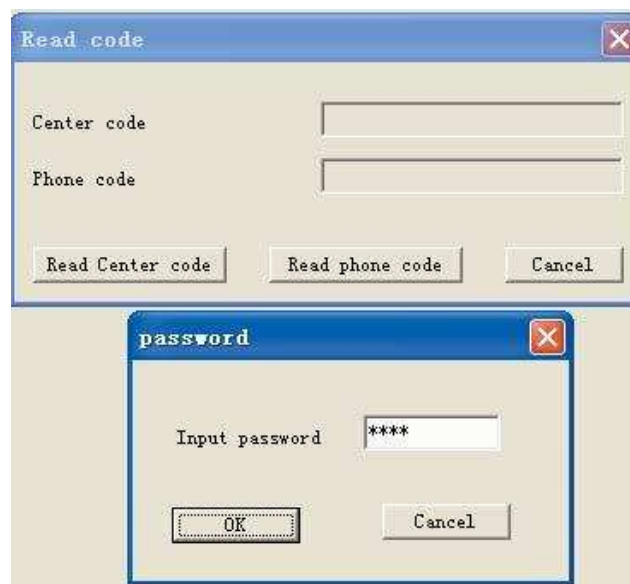

- Knob in SMS rotates to mode1. SMS work under the mode of receiving and sending short message.

Open the SMS parameter configuring software and configure the parameter

dblclick  GSMMODULE.exe open SMS configure tool, select mode

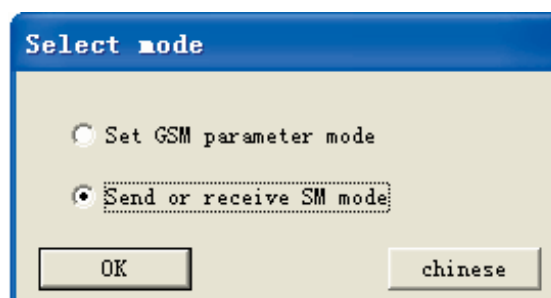

Or Click“ select mode” menu

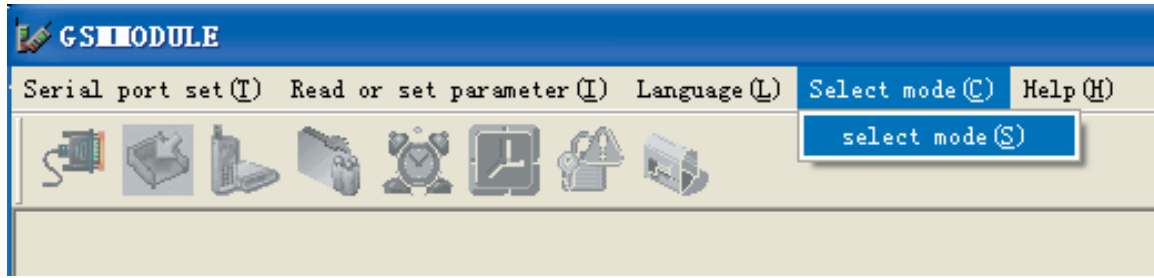

Click “ Send and receive SM (M)” input the receiver mobile phone number click “ Send SM ” if the short message is sent successfully the prompt message “ send SM Successfully” pops up

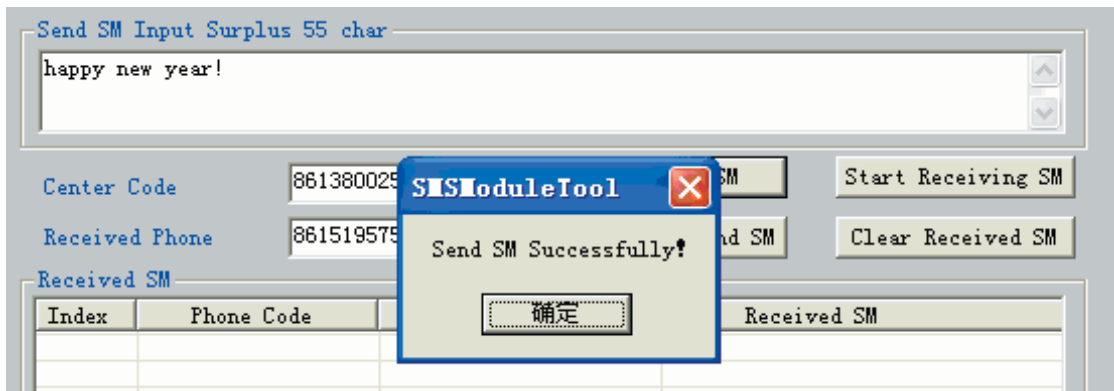

Click “ Send and receive SM (M)” select “ Start receiving SM ” if the short message is received successfully the short message will be displayed in the table

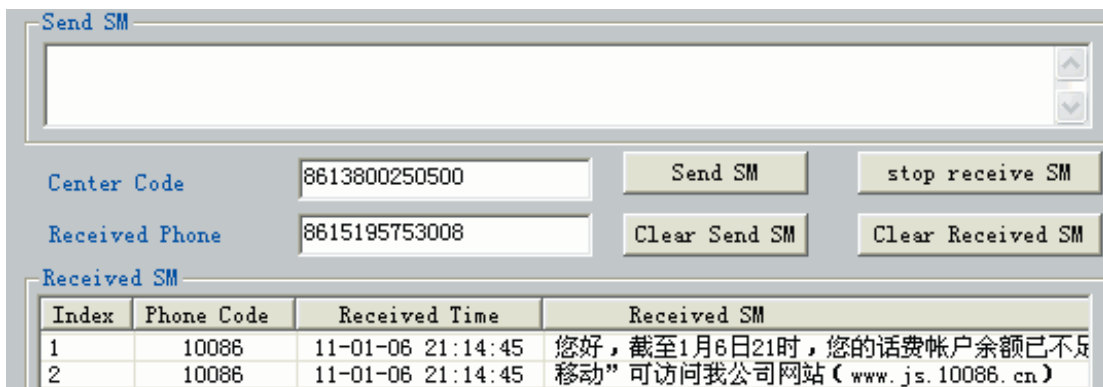

Click “ Query Record” select “ Receive” or “ Send” to query history record.

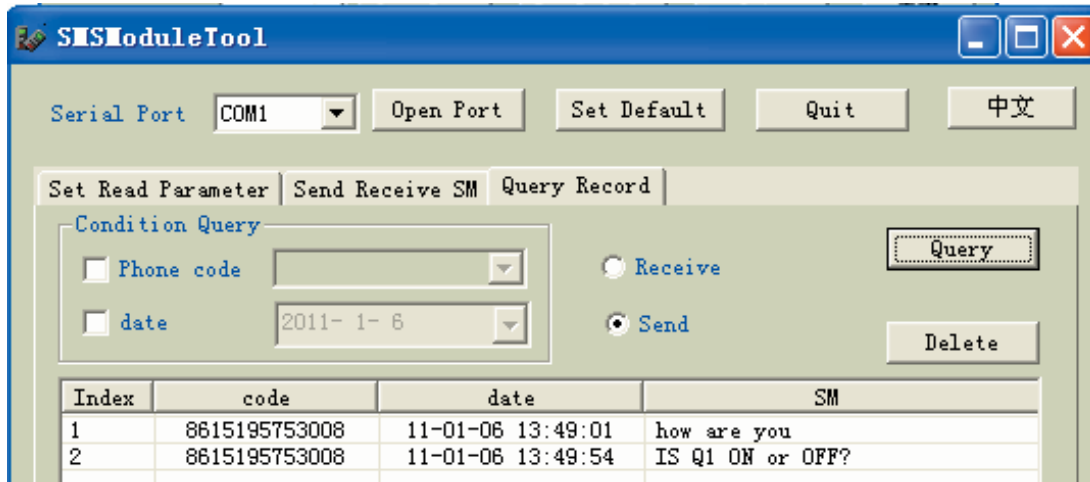

8 SMS module Sent/Received Data Format in mode 0

- he sent data format when SMS module is used independently:

Description for SMS control instruction: * is used as separator; case-insensitive; “ Section1, Section2” are relevant control codes.

*	Section1	*	Section2	*
---	----------	---	----------	---

Section1 xxxxxxxx is the password for the SMS module, which can be set through the software of host machine. The password has 8 bits at most. If there is no password, Section1 can be omitted.

Section2: instruction type; 3bits. The first bit R/W represents read or write. The last two bits represent the corresponding type.

00: Input SI0

01: Input SI1

10: Output SQ0

11: Output SQ1

*xxxxxxx*R00* Read SI0; Returned message: 0 or 1

*xxxxxxx*R01* Read SI1; Returned message: 0 or 1

*xxxxxxx*R10* Read SQ0; Returned message: 0 or 1

*xxxxxxx*R11* Read SQ1; Returned message: 0 or 1

*xxxxxxx*W11* Set SQ1 to 1; If it is set successfully, the returned message will be OK;

*xxxxxxx*W10* Set SQ1 to 0; If it is set successfully, the returned message will be OK;

- The sent data format when SMS is connected with APB:

Description for SMS control instruction: * is used as a separator; case-insensitive; “ Section1~Section4” are relevant control codes.

*	Section1	*	Section2	Section3	*	Section4	*
---	----------	---	----------	----------	---	----------	---

Section1: the password part for APB main machine; the password has 14 bits at most. If there is no password set by main machine, Section1 can be omitted.

Section2: instruction type; 2bits. The first bit R/W represents read or write. The second bit represents corresponding register type.

R/WD Read/Write register DW

R/WQ Read/Write output Q

RI Read input I

R/WM Read/Write intermediate relay M

R/WA Read/Write intermediate value (Analog) A

RB Read analog input AI

R/WC Read/Write analog output AQ

Section3: The serial number of the register; 4 bits at most

Section4: The set value; 10 bits at most; please note that the set value should stay within the valid range of the register value (used in the write instruction).

- It is necessary to program SMS function block in APB software when SMS module is used with APB.



属性 [短信模块]

备注说明

参数停电保持 高速运行

输入脚

触发

I00 输出

短信息中心地址: 8613800250500

接收方电话号码: 86137706604**

短信息:

0号开关打开

Example: If I00 is ON, the SMS function block will be triggered, and GSM module will send the message of “ Turn on switch 0” to mobile phone 137706604** .

Example: Data format *111*RI0* indicates the password is 111; read input I0 state;
If I0 is ON, 0000000001 will be returned when the I0 state has been successfully read. The last number of the returned value indicates the switch state. ON: 1; OFF: 0.

Example: Data format *111*RQ0* indicates the password is 111; read input Q0 state;
If Q0 is OFF, 0000000000 will be returned when the Q0 state has been successfully read.

Example: Data format *111*WQ0*1* indicates the password is 111; write output Q0 state;
The returned message will be OK if Q0 state has been successfully set.

Example: Data format *111*WD0023*1234567890* indicates the password is 111; set the value of register DW23 to 1234567890.

The returned message will be OK if the register value is successfully set.

Example: Data format *111*RD0023* indicates the password is 111; read the value of register DW23;

The corresponding value will be returned when the value has been successfully read.

APB Communication Module Operation Guide

1 Introduction

- Brief Description

This module is used for the interface sending APB remote signal. The combination of APB PLC and APB communication module can get networking function, which makes multiple APBs become a network with RS-485 bus, and have real-time monitoring on one HMI with MODBUS communication protocol. The user will enjoy more flexibility when designing automation solution.

- Technical Parameters

Serial data interface

Baud rate: corresponds with sending baud rate;

Data format: corresponds with sending data format;

Type/RS-232/RS-485

Power supply

Power supply: powered by APB main machine or APB expansion module;

Power consumption

Current:135mA/5VDC Communication state

Other Parameters:

Dimensions

Weight

Ambient temperature:- 20 +60

Relative humidity: (50 30 80 no condensation)

2 Connections

- Connecting with APB Main Machine

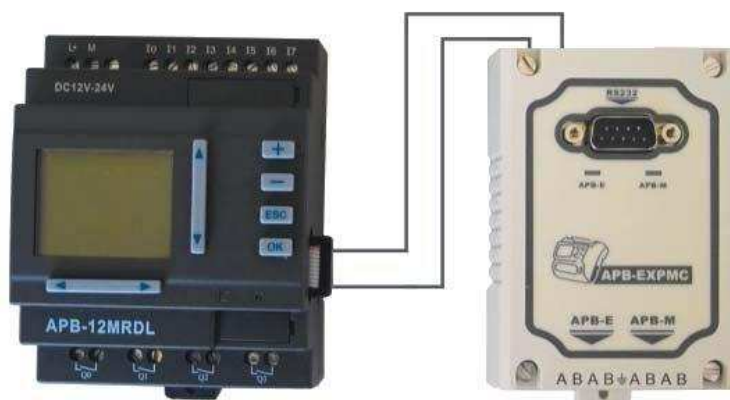

- Pin Assignment

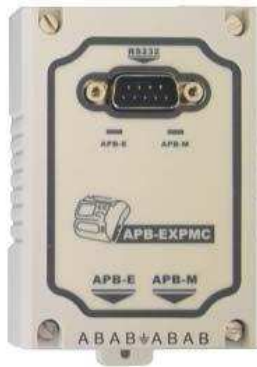

Pin assignment:

Pin	Signal Name	Description
1	RS232 interface	Used in 232 communication
2	A B	Use BA(receiving/sending terminal) when it is connected with APB expansion module
3	GND	Ground
4	A B	Use AB(receiving/sending terminal) when it is connected with APB main module

Note: Please make sure A B connection is correct when RS485 interface is used.

- Mounting Dimensions

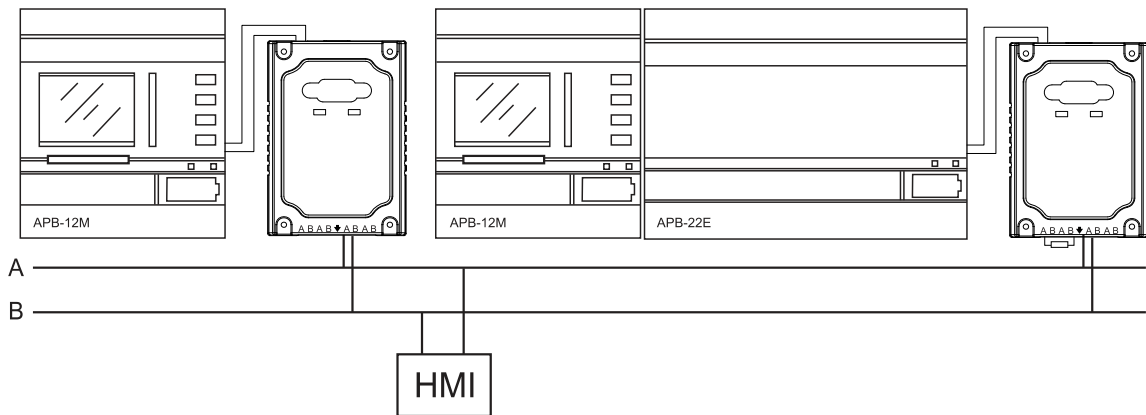

3. Indicators

APB- EXPMC has 2 indicators.

Consistent ON: indicates it is in power on state;

Flashing: indicates DTU stays in normal communication state;

APB- M: Indicates APB is communicating with main machine;

APB- E: Indicates APB is communicating with expansion module;